

Project	
Date	
Prepared by	
Model #	

FL4C-SERIES ACCESSORIES

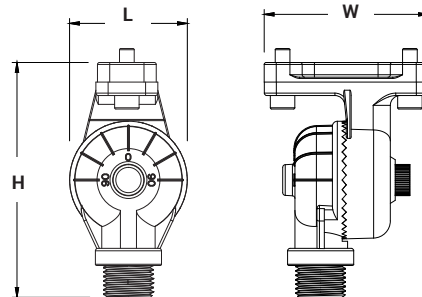

PRODUCT INFORMATION	
Model #	FL4C-KN
Description	Knuckle mount for mounting with 1/2" NPT thread for 30W, 50W FL4C
Material	Aluminum alloy
Compatible with	FL4C 30W, 50W
Dimensions	L: 1 7/8" (48mm) W: 2 5/8" (67mm) H: 3 3/4" (96mm)



PRODUCT INFORMATION	
Model #	FL4C-KN-L
Description	Knuckle mount for mounting with 1/2" NPT thread for 70W, 90W FL4C
Material	Aluminum alloy
Compatible with	FL4C 70W, 90W
Dimensions	L: 1 5/8" (42mm) W: 2 5/8" (67mm) H: 3 13/16" (97mm)

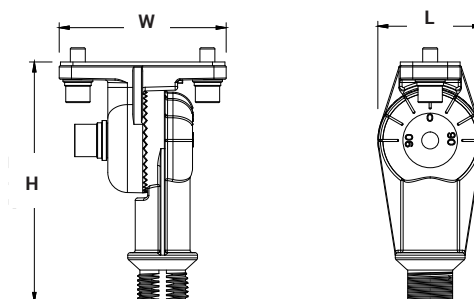



FL4C-SERIES ACCESSORIES

Project	
Date	
Prepared by	
Model #	



PRODUCT INFORMATION	
Model #	FL4C-YK-S
Description	Yoke mount for flat surfaces for 30W FL4C
Material	Aluminum alloy
Compatible with	FL4C 30W
Dimensions	L: 1 5/16" (33mm) W: 7 3/8" (187mm) H: 4 9/16" (116mm)

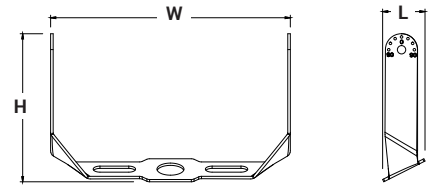
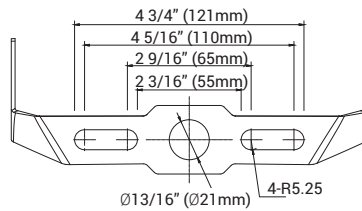

PRODUCT INFORMATION	
Model #	FL4C-YK-M
Description	Yoke mount for flat surfaces for 50W FL4C
Material	Aluminum alloy
Compatible with	FL4C 50W
Dimensions	L: 1 5/16" (33mm) W: 8 13/4" (222mm) H: 5 5/16" (136mm)

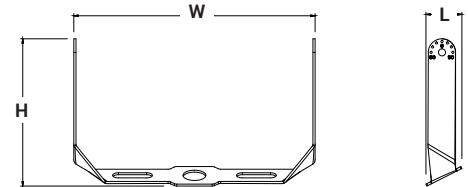
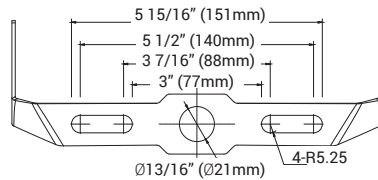

PRODUCT INFORMATION	
Model #	FL4C -YK-L
Description	Yoke mount for flat surfaces for 70W, 90W FL4C
Material	Aluminum alloy
Compatible with	FL4C 70W, 90W
Dimensions	L: 1 5/16" (33mm) W: 10 11/16" (272mm) H: 6" (153mm)

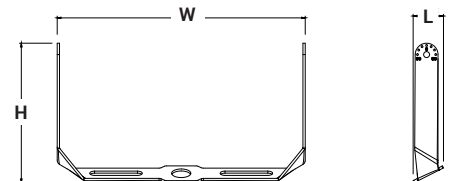
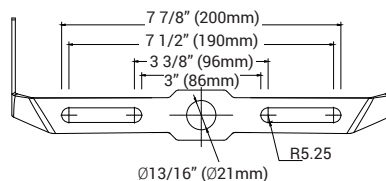

Project	
Date	
Prepared by	
Model #	

FL4C-SERIES ACCESSORIES



PRODUCT INFORMATION	
Model #	FL4C-TR
Description	Trunnion mount for flat surfaces for 30W, 50W FL4C
Material	Aluminum alloy
Compatible with	FL4C 30W, 50W
Dimensions	L: 1" (25mm) W: 3 3/8" (85mm) H: 2 5/8" (67mm)

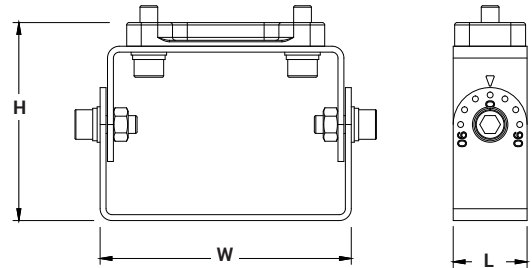
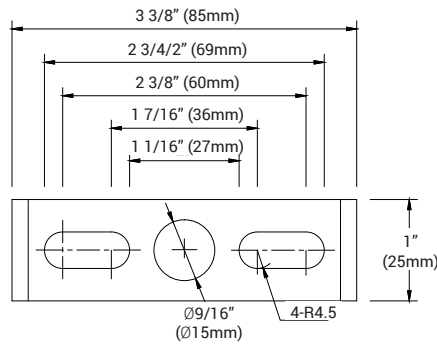

PRODUCT INFORMATION	
Model #	FL4C-TR-L
Description	Trunnion mount for flat surfaces for 70W, 90W FL4C
Material	Aluminum alloy
Compatible with	FL4C 70W, 90W
Dimensions	L: 1 1/2" (38mm) W: 5 9/16" (141mm) H: 3 5/16" (84mm)

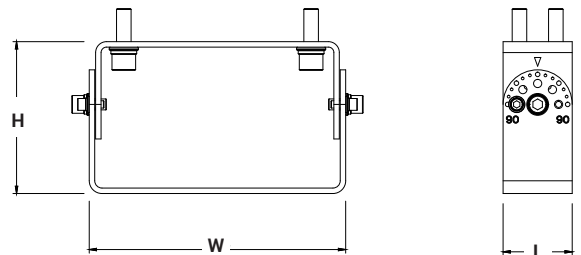
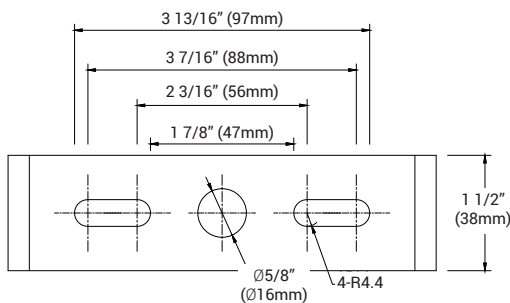

Project	
Date	
Prepared by	
Model #	

FL4C-SERIES ACCESSORIES

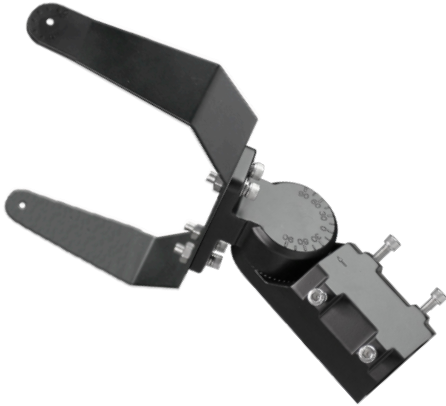

PRODUCT INFORMATION	
Model #	FL4C-SF-S
Description	Slip fitter to mount on a 2" to 2 3/8" tenon for 30W FL4C
Material	Aluminum alloy
Compatible with	FL4C 30W 2" to 2 3/8" tenon
Dimensions	L: 3" (77mm) W: 7 3/8" (187mm) H: 12 1/2" (318mm)

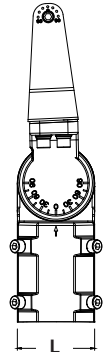
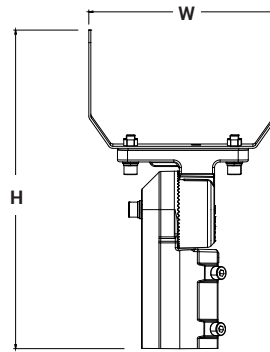
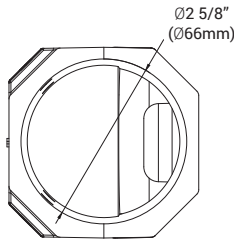

PRODUCT INFORMATION	
Model #	FL4C-SF-M
Description	Slip fitter to mount on a 2" to 2 3/8" tenon for 50W FL4C
Material	Aluminum alloy
Compatible with	FL4C 50W 2" to 2 3/8" tenon
Dimensions	L: 3" (77mm) W: 8 3/4" (222mm) H: 13" (331mm)

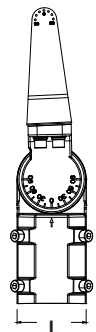
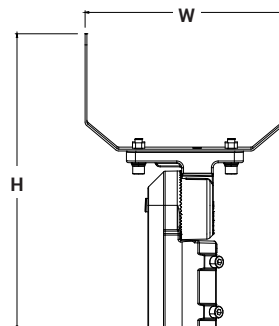
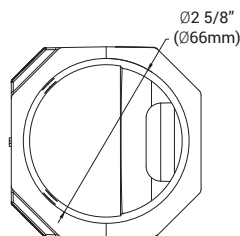

Project	
Date	
Prepared by	
Model #	

FL4C-SERIES ACCESSORIES



PRODUCT INFORMATION	
Model #	FL4C-SF-L
Description	Slip fitter to mount on a 2" to 2 3/8" tenon for 70W, 90W FL4C
Material	Aluminum alloy
Compatible with	FL4C 70W, 90W 2" to 2 3/8" tenon
Dimensions	L: 3" (77mm) W: 5 3/16" (131mm) H: 8 1/16" (205mm)

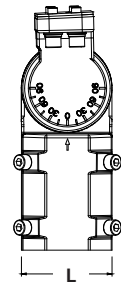
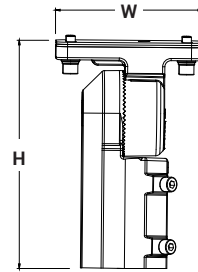
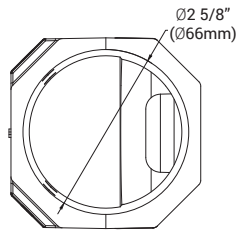

PRODUCT INFORMATION	
Model #	FL4C-MA-L
Description	Mounting arm for 4" to 5" round poles or 4"+ square poles for 70W, 90W FL4C
Material	Aluminum alloy
Compatible with	FL4C 70W, 90W 4" or 5" round poles 4" or larger square poles
Dimensions	L: 6 5/16" (160mm) W: 5 1/8" (130mm) H: 9" (228mm)

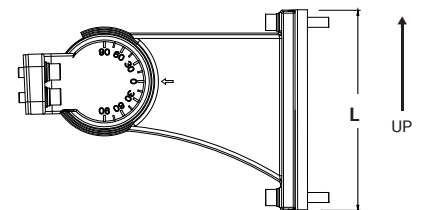
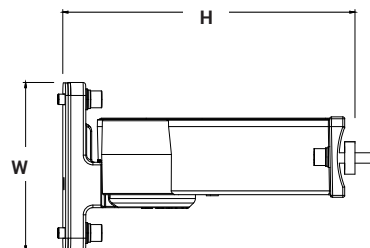
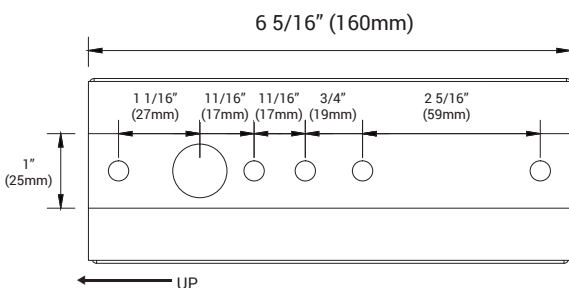

Project	
Date	
Prepared by	
Model #	

FL4C-SERIES ACCESSORIES



PRODUCT INFORMATION	
Model #	FL4C-MA-S
Description	Mounting arm for 4" to 5" round poles or 4"+ square poles for 30W FL4C
Material	Aluminum alloy
Compatible with	FL4C 30W 4" or 5" round poles 4" or larger square poles
Dimensions	L: 6 5/16" (160mm) W: 7 3/8" (187mm) H: 13 7/16" (342mm)

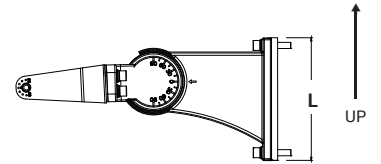
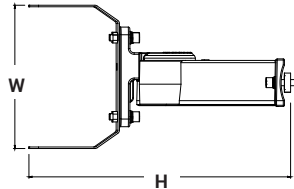
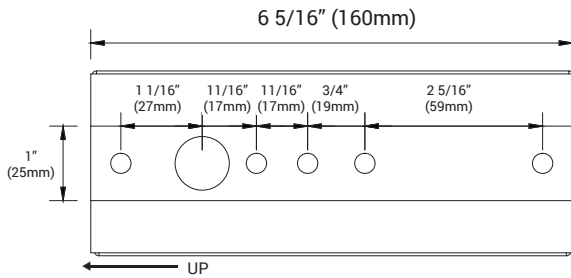

PRODUCT INFORMATION	
Model #	FL4C-MA-M
Description	Mounting arm for 4" to 5" round poles or 4"+ square poles for 50W FL4C
Material	Aluminum alloy
Compatible with	FL4C 50W 4" or 5" round poles 4" or larger square poles
Dimensions	L: 6 5/16" (160mm) W: 8 3/4" (222mm) H: 13 15/16" (354mm)

