



# WESTPORT Cylinder Wall Sconce Cylinder Surface Mount

## FEATURES

- Provides comfortable diffused light
- Switchable array to conveniently funnel light up, down or both up and down simultaneously (CWSP models only)
- Integrated photocell ON/OFF switch to easily disable photo control based on installation needs (CWSP & CWSW 6" models only)

## CERTIFICATIONS

- Wall Sconce: UL Listed for wet locations
- Surface mount: UL Listed for dry locations
- ENERGY STAR® Approved for superior energy efficiency

## PERFORMANCE

- Rated lifetime L70 > 50,000 hours
- 30/40/5000K CCT
- CRI: >80; >90
- Up to 90 LPW
- Beam angles, 50°/ 80° depending on size

## ELECTRICAL

- Input voltage: 120-277VAC 50/60Hz
- Power Factor: >0.9
- THD: <20%
- 2kV surge protection

## THERMAL

- -22°F to 122°F (-30°C to 50°C)

## CONSTRUCTION

- Aluminum construction
- Black or bronze finish

## WARRANTY

- 5 year limited warranty. Additional warranty options available. Contact EiKO for details

project name	type
catalog number	voltage
approved by	date



## APPLICATIONS

- Residential
- Hospitality
- Multi Family
- Retail

## CONFIGURATOR

MODEL	SIZE/DIRECTION	WATTS	CRI/CCT	VOLTAGE	DIMMING	PHOTOCELL	FINISH
CWSP : Cylinder Wall Sconce - Westport (Power & CCT Selectable)	3S - 3"; Switchable	10W - 5/10W	8CCT3 - 80 CRI; 30/40/5000K	UNV - 120-277V	[Blank] - None	PC - Photocell (with ON/OFF switch)	BK - Black BZ - Bronze
	4S - 4"; Switchable	20W - 10/20W					
	6S - 6"; Switchable	36W - 18/36W					
CSMW : Cylinder Surface Mount - Westport (CCT Selectable)	61 - 6"; 1 Light	30W - 30W			DIM - 0-10V	[Blank] - None	

MODEL	ARRAY	LUMENS	WATTS	CRI/CCT	VOLTAGE	DIMMING	PHOTOCELL	FINISH			
CWSWP : Cylinder Wall Sconce & Surface Mount - Westport	31 - 3"; 1 Light	75 - 750 lm	10W - 10W	930 - >90 CRI; 3000K	U - 120-277V	[Blank] - None	[Blank] - None	BK - Black BZ - Bronze			
	32 - 3"; 2 Lights		20W - 20W								
	42 - 4"; 2 Lights	150 - 1,500 lm	18W - 18W						830 - >80 CRI; 3000K	[Blank] - None	PH - Photocell
	61 - 6"; 1 Light	162 - 1,620 lm	36W - 36W								
	62 - 6"; 2 Lights	324 - 3,240 lm									
CSMWP : Cylinder Surface Mount - Westport	61 - 6"; 1 Light	270 - 2,700 lm	30W - 30W	830 - >80 CRI; 3000K	U - 120-277V	DIM - 0-10V	[Blank] - None	BK - Black BZ - Bronze			



## PERFORMANCE SUMMARY

ORDER CODE	ITEM #	SIZE	WATTS	LUMENS	CCT	CRI	VOLTS	PHOTO CELL	FINISH	WET/DRY LOCATION	BEAM	ENERGY STAR®
12547	CWSP3S/10W/8CCT3/UNV/PC/BK	3"	5/10W	800	30/40/5000K	>80	120-277V	✓	Black	Wet	50°	★
12548	CWSP3S/10W/8CCT3/UNV/PC/BZ	3"	5/10W	800	30/40/5000K	>80	120-277V	✓	Bronze	Wet	50°	★
12549	CWSP4S/20W/8CCT3/UNV/PC/BK	4"	10/20W	1,600	30/40/5000K	>80	120-277V	✓	Black	Wet	50°	★
12550	CWSP4S/20W/8CCT3/UNV/PC/BZ	4"	10/20W	1,600	30/40/5000K	>80	120-277V	✓	Bronze	Wet	50°	★
12526	CWSP6S/36W/8CCT3/UNV/PC/BK	6"	18/36W	3,600	30/40/5000K	>80	120-277V	✓	Black	Wet	80°	★
12527	CWSP6S/36W/8CCT3/UNV/PC/BZ	6"	18/36W	3,600	30/40/5000K	>80	120-277V	✓	Bronze	Wet	80°	★
12528	CSMWP61/30W/8CCT3/UNV/DIM/BK	6"	30W	3,000	30/40/5000K	>80	120-277V		Black	Dry	80°	★
12551	CSMWP61/30W/8CCT3/UNV/DIM/BZ	6"	30W	3,000	30/40/5000K	>80	120-277V		Bronze	Dry	80°	★

## PERFORMANCE SUMMARY

ORDER CODE	ITEM #	ARRAY	WATTS	LUMENS	CCT	CRI	VOLTS	PHOTO-CELL	FINISH	BEAM	ENERGY STAR®
11406	CWSWP31-75-10W-930-U-BK	3"; 1 Light	10W	750	3000K	>90	120-277V		Black	50°	★
11407	CWSWP31-75-10W-930-U-BZ	3"; 1 Light	10W	750	3000K	>90	120-277V		Bronze	50°	★
11410	CWSWP32-75-10W-930-U-BK	3"; 2 Lights	5W/5W*	375/375*	3000K	>90	120-277V		Black	50°	★
11411	CWSWP32-75-10W-930-U-BZ	3"; 2 Lights	5W/5W*	375/375*	3000K	>90	120-277V		Bronze	50°	★
11412	CWSWP42-150-20W-930-U-BK	4"; 2 Lights	10W/10W*	750/750*	3000K	>90	120-277V		Black	50°	★
11413	CWSWP42-150-20W-930-U-BZ	4"; 2 Lights	10W/10W*	750/750*	3000K	>90	120-277V		Bronze	50°	★
11408	CWSWP61-162-18W-830-U-PH-BK	6"; 1 Light	18W	1,620	3000K	>80	120-277V	✓	Black	80°	★
11409	CWSWP61-162-18W-830-U-PH-BZ	6"; 1 Light	18W	1,620	3000K	>80	120-277V	✓	Bronze	80°	★
11417	CWSWP62-324-36W-830-U-PH-BK	6"; 2 Lights	18W/18W*	1,620/1,620*	3000K	>80	120-277V	✓	Black	80°	★
11418	CWSWP62-324-36W-830-U-PH-BZ	6"; 2 Lights	18W/18W*	1,620/1,620*	3000K	>80	120-277V	✓	Bronze	80°	★
11419	CSMWP61-270-30W-830-U-DIM-BK	6"; 1 light	30W	2,700	3000K	>80	120-277V		Black	80°	★
11420	CSMWP61-270-30W-830-U-DIM-BZ	6"; 1 light	30W	2,700	3000K	>80	120-277V		Bronze	80°	★

\*Watt and Lumen values are per light; two values are shown for two-light arrays

## ACCESSORIES

ORDER CODE	ITEM #	DESCRIPTION	LENGTH
11421	CSMPENACC-BK	Pendant Accessory Black	33-1/2" / 850mm
11422	CSMPENACC-BZ	Pendant Accessory Bronze	33-1/2" / 850mm

## PRODUCT DIMENSIONS

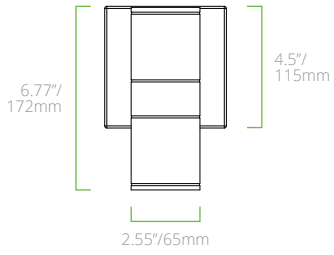

**3" WALL SCONCE SWITCHABLE ARRAY (CWSP3S)**

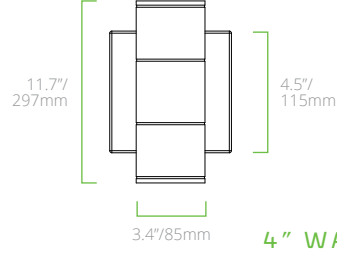
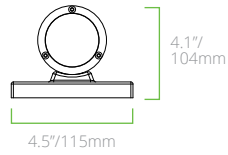

**4" WALL SCONCE SWITCHABLE ARRAY (CWSP4S)**

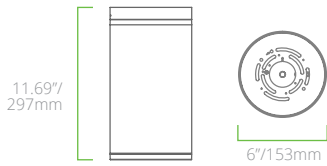
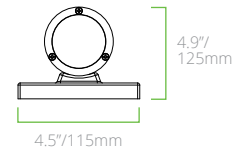

**6" SURFACE MOUNT SWITCHABLE ARRAY (CSMW61)**

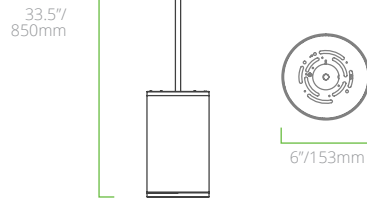

**6" PENDANT MOUNT (CSMW61 WITH PENDANT)**

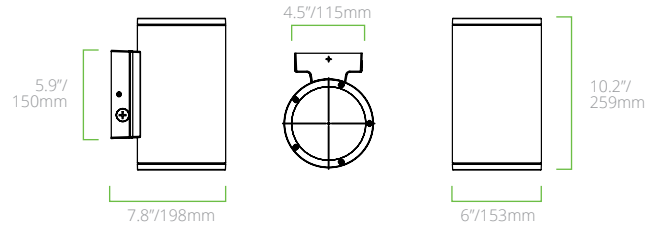

**6" WALL SCONCE SWITCHABLE (CWSP6S)**

## PRODUCT DIMENSIONS

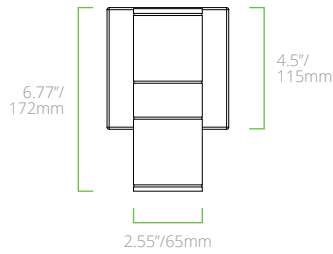

**3" 1 LIGHT (CWSW31)**

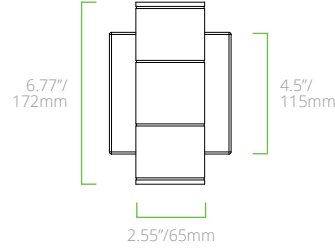

**3" 2 LIGHT (CWSW32)**

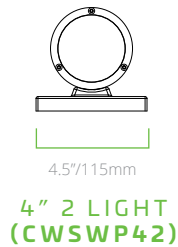
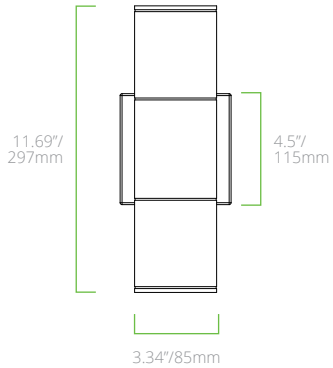
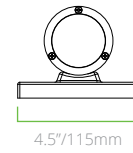

**4" 2 LIGHT (CWSWP42)**

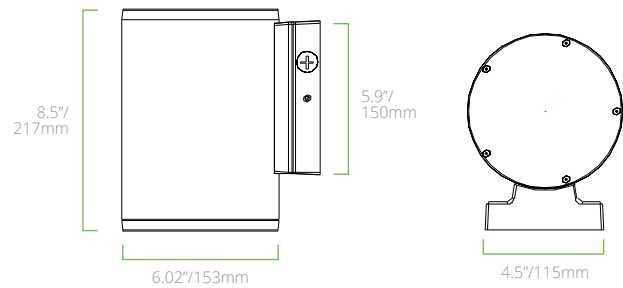

**6" 1 LIGHT (CWSWP61)**

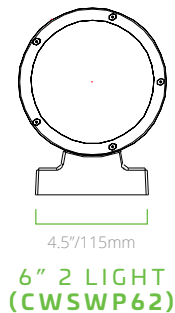
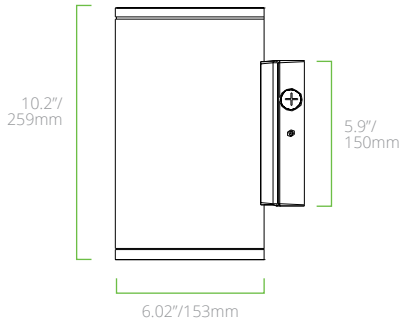

**6" 2 LIGHT (CWSWP62)**

# PRODUCT DIMENSIONS

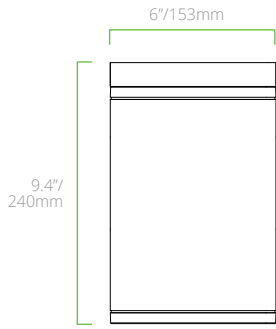

**SURFACE MOUNT  
(CSMWP61)**

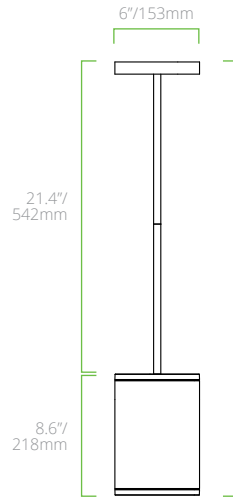
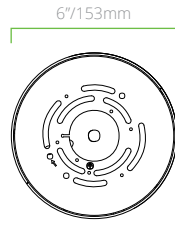

**PENDANT MOUNT  
(CSMWP61 WITH PENDANT)**

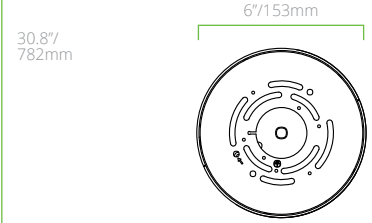

## PHOTOMETRIC INFORMATION - CSMWP61/30W/8WCCT3/UNV/DIM

### POLAR CANDELA DISTRIBUTION

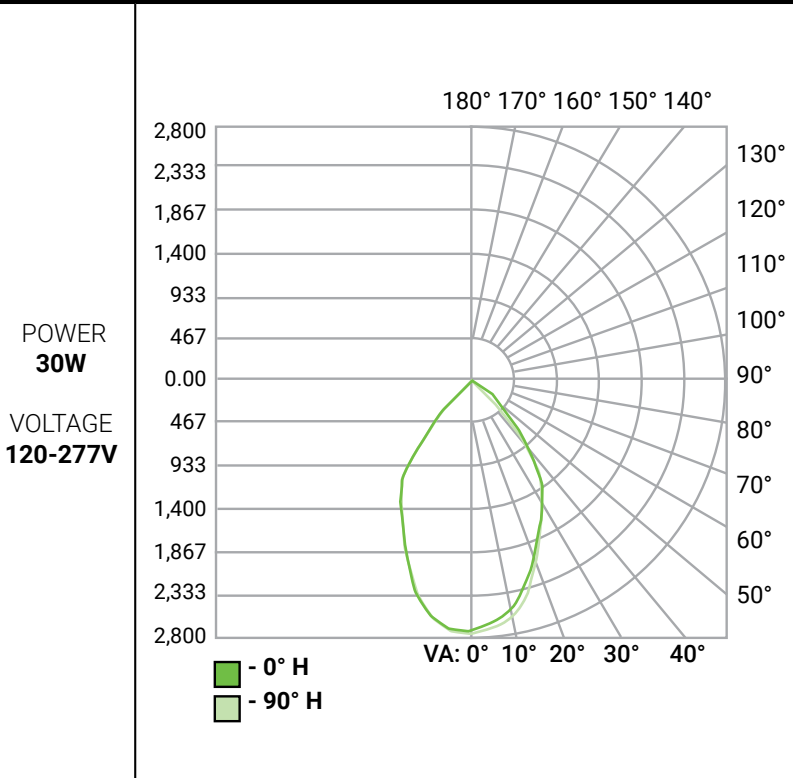

### ILLUMINANCE AT A DISTANCE

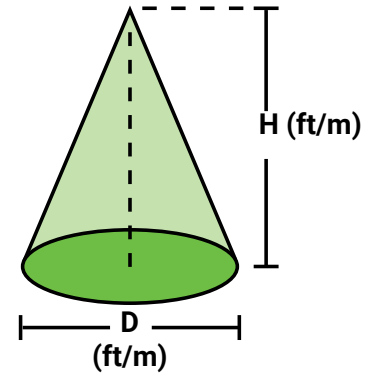

H (ft/m)	LUX	FC	D (ft/m)
6.6' (2m)	692.03	64.29	12.2' (3.7m)
9.8' (3m)	307.57	28.57	18.4' (5.6m)
13.1' (4m)	173.01	16.07	24.3' (7.4m)
16.4' (5m)	110.73	10.29	30.6' (9.3m)
19.7' (6m)	76.89	7.14	36.5' (11.1m)

\*Based on operation at 4000K & 120V.

**PHOTOMETRIC INFORMATION - CWSP3S/PS10/8CCT3/UNV/PC**

**POLAR CANDELA DISTRIBUTION**

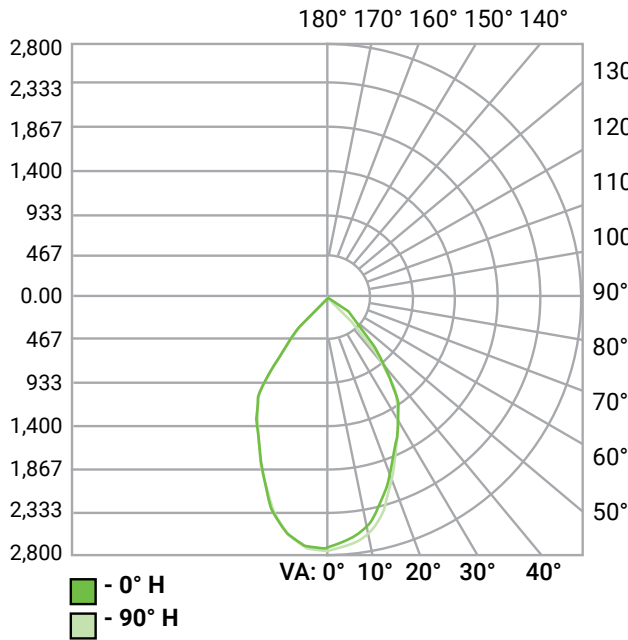

POWER  
**10W**  
VOLTAGE  
**120-277V**

**ILLUMINANCE AT A DISTANCE**

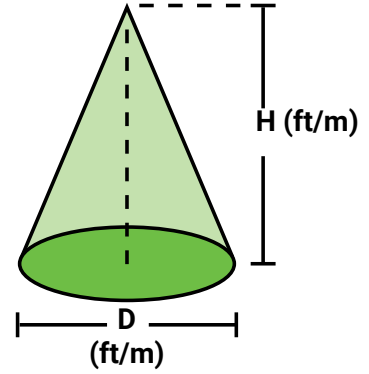

H (ft/m)	LUX	FC	D (ft/m)
6.6' (2m)	199.50	18.53	12.2' (3.7m)
9.8' (3m)	88.67	28.57	18.4' (5.6m)
13.1' (4m)	49.88	16.07	24.3' (7.4m)
16.4' (5m)	31.92	10.29	30.6' (9.3m)
19.7' (6m)	22.17	7.14	36.5' (11.1m)

\*Based on operation at 4000K & 120V.

**PHOTOMETRIC INFORMATION - CWSP4S/PS20/8CCT3/UNV/PC**

**POLAR CANDELA DISTRIBUTION**

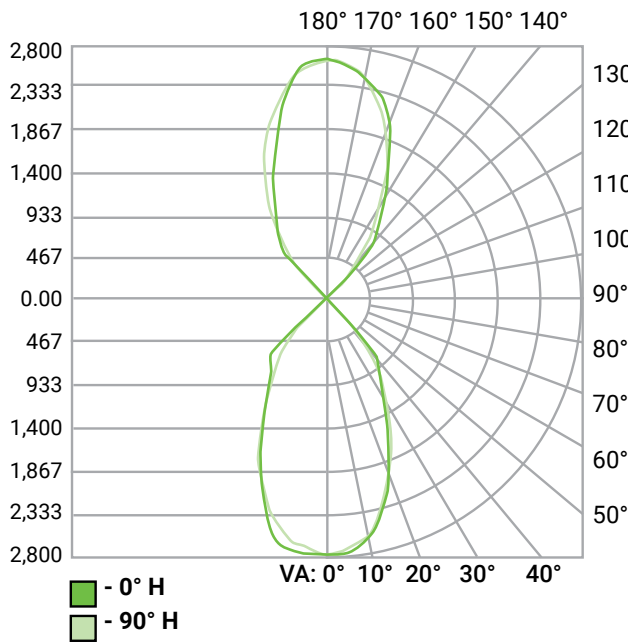

POWER  
**20W**  
VOLTAGE  
**120-277V**

**ILLUMINANCE AT A DISTANCE**

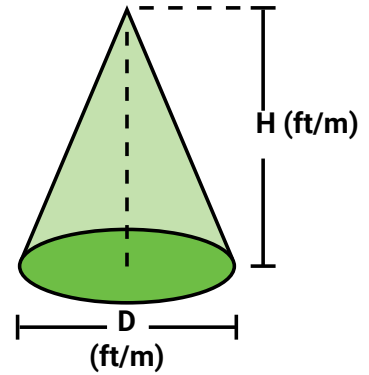

H (ft/m)	LUX	FC	D (ft/m)
6.6' (2m)	242.31	22.51	12.2' (3.7m)
9.8' (3m)	107.60	10.00	18.4' (5.6m)
13.1' (4m)	60.58	5.63	24.3' (7.4m)
16.4' (5m)	38.77	3.60	30.6' (9.3m)
19.7' (6m)	26.92	2.50	36.5' (11.1m)

\*Based on operation at 4000K & 120V. Illumination at a distance, for downlight portion only.

PHOTOMETRIC INFORMATION - CWSP6S/36W/8CCT3/UNV/PC

POLAR CANDELA DISTRIBUTION

ILLUMINANCE AT A DISTANCE

POWER  
**36W**  
VOLTAGE  
**120-277V**

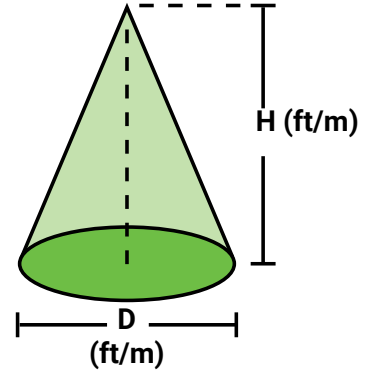
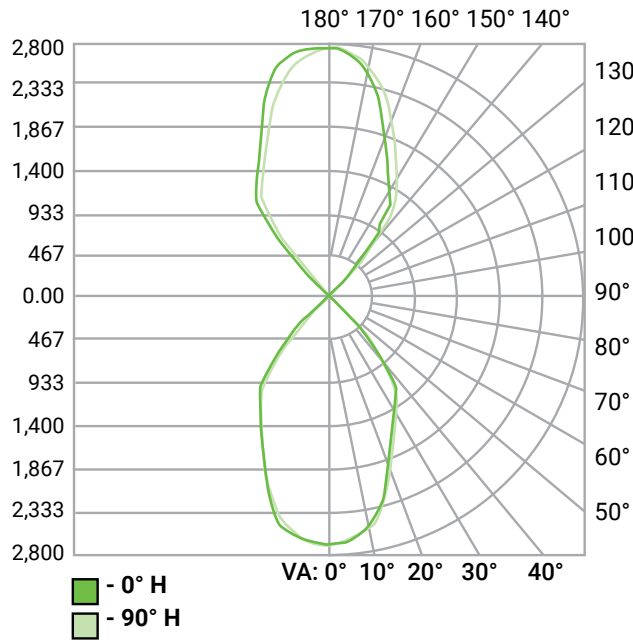

H (ft/m)	LUX	FC	D (ft/m)
6.6' (2m)	463.15	43.03	12.2' (3.7m)
9.8' (3m)	205.81	19.12	18.4' (5.6m)
13.1' (4m)	115.79	10.76	24.3' (7.4m)
16.4' (5m)	74.10	6.88	30.6' (9.3m)
19.7' (6m)	51.46	4.78	36.5' (11.1m)

\*Based on operation at 4000K & 120V.