



# VL1 Volumetric Troffer

## HIGHLIGHTS

- Architectural recessed luminaire featuring Controls Ready
- Controls Ready makes adding controls quick and easy. Includes snap-in receptacle for Standalone (Sept '23) and Networked Lighting Controls
- Flat modern lens featuring high-quality, non-yellowing PMMA acrylic lens ensures optimal light uniformity
- Multiple mounting options: recessed, suspended, surface mount
- Available in 1'x4', 2'x2' and 2'x4' sizes
- PowerSet feature allows for multiple lumen stops out of the box
- FieldCCeT features provides multiple color temperature settings in one fixture

## CERTIFICATIONS

- UL listed for US & Canada
- RoHS Compliant
- FCC Compliant
- ICES-005 Compliant
- IC Rated for insulation contact
- Damp Location rated
- DesignLights Consortium® Qualified - meets DLC requirements for efficacy and lumen maintenance

## PERFORMANCE

- High efficacy, up to 140 lm/W
- Available in PowerSet models: power-selectable 35/30/22W, 45/35/26W, 90/75/65W
- Available in FieldCCeT models: fieldselectable CCT 35/40/5000K
- CRI: >80
- Estimated L70: 100,000 Hours

## ELECTRICAL

- Input voltage: 120-277V or 120-347V
- 0-10V dimming, dim-to-off
- 12VDC Aux, 100mA max
- Surge Protection: 2.5 kV
- Power Factor: >0.9
- THD: <20%

## THERMAL

- -40°F to 122°F (-40°C to 50°C) ambient operating temperature
- Ambient operating temperature with sensor (see selected sensor datasheet)

## CONSTRUCTION

- White powder coated steel housing
- IK07 Rated non-yellowing PMMA light diffusing acrylic lens

## WARRANTY

- 5-Year limited warranty available [online](#). Contact your EIKO sales rep for additional details.

project name	type
catalog number	voltage
approved by	date



1X4



2X2



2X4



## APPLICATIONS

- Campus
- Classroom
- Hospital
- Office
- Retail
- Schools

## KEY FEATURES

### SELECTABLE CCT AND WATTAGE

Choose your CCT and Wattage upon install; great for SKU reduction and job site flexibility

### CONTROLS READY

Easily add controls anytime without the need for additional wiring by using the snap-in receptacle. Simply remove the cover and then snap-in the standalone (Sept '23) or networked lighting control solution.

### MULTIPLE MOUNTING OPTIONS

Fixture can be recessed, surface or cable mounted. Surface and cable mount kit sold separately.



## AVAILABLE MODELS (ALL MODELS ARE CONROLS READY)

ORDER	ORDER CODE	ITEM #	SIZE	WATTS*	CCT**	LUMENS	EFFICACY (lm/W)	VOLTAGE	TRADITIONAL WATTAGE EQUIVALENT	DLC ID#
										STANDARD
<b>1x4</b>										
	13792	VL1-14PS35-FCCT-H	1x4	35/30/22W	3500/4000/5000K	4900/4200/3080 lm	140 lm/W	120-347VAC	3x 17WT8, 2U31T8 Fluorescent	S-KZD6IB
<b>2x2</b>										
	13794	VL1-22PS35-FCCT-H	2x2	35/30/22W	3500/4000/5000K	4900/4200/3080 lm	140 lm/W	120-347VAC	3x 17WT8, 2U31T8 Fluorescent	S-R2U8EH
<b>2x4</b>										
	13796	VL1-24PS45-FCCT-H	2x4	45/35/26W	3500/4000/5000K	6300/4900/3640 lm	140 lm/W	120-347VAC	2x 32T8, 3x 32T8 Fluorescent	S-X93JM5
	13797	VL1-24PS45-FCCT-U	2x4	45/35/22W	3500/4000/5000K	6300/4900/3640 lm	140 lm/W	120-277VAC	2x 32T8, 3x 32T8 Fluorescent	S-3QDI4R
	13798	VL1-24PS90-FCCT-H	2x4	90/75/65W	3500/4000/5000K	12,600/10,500/9100 lm	140 lm/W	120-347VAC	6x T8, 4x T5 Fluorescent	S-3VRSZP

\* All power-selectable fixtures ship at the highest wattage setting

\*\* All CCT-selectable fixtures ship at 4000K

### FACTORY INSTALLED OPTIONS

CUSTOM CORD LENGTH	EMERGENCY BATTERY	CONTROLS
<p><b>[Blank]:</b> Default no cord</p> <p><b>A1xx:</b> 300V 18/3 armored cable, XX to specify length up to 99'</p> <p><b>A2xx*:</b> 600V 18/3 armored cable, XX to specify length up to 99'</p> <p>Custom length required (in feet)</p>	<p><b>[Blank]:</b> Default, no battery back-up</p> <p><b>EB08*:</b> 8W External Battery Backup, 100-347V</p> <p><b>EB18*:</b> 18W External Battery Backup, 100-347V</p> <p><b>EB40*:</b> 40W External Battery Backup, 100-347V</p>	<p><b>[Blank]:</b> Default, no controls</p> <p><b>M14:</b> Stand-alone PIR Motion Sensor, 8-12ft</p> <p><b>M21:</b> Bluetooth NLC PIR Motion sensor, 8-12ft</p>

\* Batteries are wired, not secured to fixture.

### MODEL CONFIGURATOR





### FACTORY INSTALLED OPTIONS

MODEL	-	SIZE	-	WATTS	-	FCCT	-	VOLTAGE	-	CORD LENGTH	-	EMERGENCY BATTERY	-	CONTROLS
<b>VL1</b>	-		-		-		-		-		-		-	

EXAMPLE PART NUMBER: PART NUMBER FROM AVAILABLE MODELS FOLLOWED BY -A110-EB08-M14

REFER TO FOLLOWING SECTIONS FOR DETAILS ON FACTORY INSTALLED OPTIONS & AVAILABLE FIELD INSTALLED OPTIONS

## ACCESSORIES

ORDER	ORDER CODE	ITEM #	DESCRIPTION
<b>MOUNTING ACCESSORIES</b>			
	13913	FP1-RMK-14*	FP1 Recessed Mount Kit For 1x4 Flat Panels and Troffers 
	13914	FP1-RMK-22*	FP1 Recessed Mount Kit For 2x2 Flat Panels and Troffers 
	13915	FP1-RMK-24*	FP1 Recessed Mount Kit For 2x4 Flat Panels and Troffers 
	13909	FP1-SMK-14*	FP1 Surface Mount Kit For 1x4 Flat Panels and Troffers 

## ACCESSORIES CONT'D

ORDER	ORDER CODE	ITEM #	DESCRIPTION
<b>MOUNTING ACCESSORIES</b>			
	13908	FP1-SMK-22*	FP1 Surface Mount Kit For 2x2 Flat Panels and Troffers
	13912	FP1-SMK-24*	FP1 Surface Mount Kit For 2x4 Flat Panels and Troffers



\* Visit [eiko.com](http://eiko.com) for compatible alternate from previous generation.

## BATTERY BACKUPS

ORDER	ORDER CODE	ITEM #	DESCRIPTION	FACTORY INSTALLED CODE
	11674	EEBE08WHA170S* (**)	EiKO Emergency Battery External 8W 120-347V 170VDC CEC Compliant. Factory or field install. See spec sheet for full details.	EB08
	11675	EEBE18WHA170S*	EiKO Emergency Battery External 18W 100-347V 170VDC Single Flex-Conduit CEC Compliant. Factory or field install. See spec sheet for full details.	EB18
	13574	EEBE40WHA170S*	EiKO Emergency Battery External 40W 100-347VAC 170VDC Linear Single Flex-Conduit CEC Compliant. Factory or field install. See spec sheet for full details.	EB40

\* **WARNING:** When using these AC version battery backups with any control solution, internal rewiring is required according to the installation sheet's wiring diagram. Failure to do so may result in a violation of safety codes.

\*\* Not compatible with 90W models

## CONTROLS & SENSORS: FIELD OR FACTORY INSTALLED INSTALLED

ORDER	ORDER CODE	ITEM #	DESCRIPTION	FACTORY INSTALLED CODE
<b>STANDALONE CONTROLS</b>				
<b>PIR SENSORS</b>				
AVAILABLE SEPT '23	13697	SENA-SHPR	Stand-alone PIR Motion Sensor, 12-24V, 1/2" Button Snap-in, 0-10V, Daylight Harvesting, 8-12ft, Parameters set by SEN5A-ACT.	M14

<b>REMOTES FOR COMMISSIONING STANDALONE CONTROLS</b>				
	13344	SEN5A-ACT	Commissioning Tool for SEN5A, BAY-E-SEN/PIR, BAY-E-SEN/M, and MS2-DPX-3 (Backward compatible with SEN5A/CT and RC-100)	---

<b>NETWORKED LIGHTING CONTROLS (NLC)</b>				
<b>SENSOR AND CONTROLLER</b>				
	13245	SENA-WHPA	BLE PIR Motion sensor, 12-24V, 1/2" Button Snap-in, 0-10V, Daylight Harvesting, 8-12ft, Parameters set by Silvoir App	M21
	13359	SENA-WCPA	BLE PIR Motion sensor, 12-24V, Ceiling Mount, 0-10V, Daylight Harvesting, 12ft, OD3.3" WhiteTrim (ID2.7"), Parameters set by Silvoir App	---
<b>WALL OR WIRELESS CONTROLLERS</b>				
	12654	ESRPB-W-EO	BLE Easyfit by EnOcean wireless self-powered kinetic Single rocker pad, white, wall plate included.	---
	12655	EDRPB-W-EO	BLE Easyfit by EnOcean wireless self-powered kinetic Double rocker pad, white, wall plate included.	---
	12635	PSC-DM-WS-100-BLE-SR	BLE TruBlu 120-277V, Single Gang Single Button Wall Controller, White, Parameters set by Silvoir App.	---
	12636	PSC-DM-I-WS-100-BLE-SR	BLE TruBlu PIR Occupancy/ Vacancy Sensor, 120-277V, Single Gang Wall Controller, White, Parameters set by Silvoir App.	---
	12637	PSC-DM-WS-400-BLE-SR	BLE TruBlu 120-277V, Single Gang 4-Button Wall Controller, White, Parameters set by Silvoir App.	---

# PRODUCT DIMENSIONS

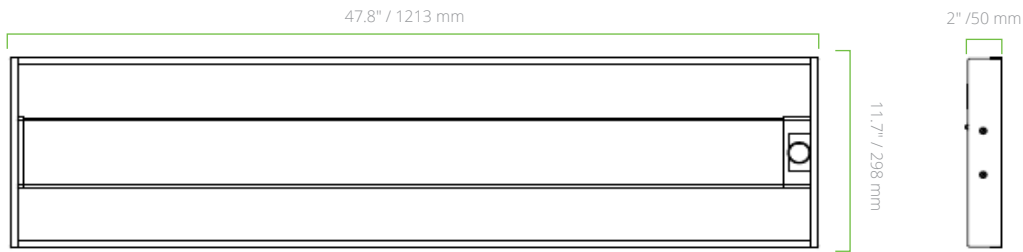

## 1X4 MODELS

Weight: 7.7 lbs / 3.5 kg

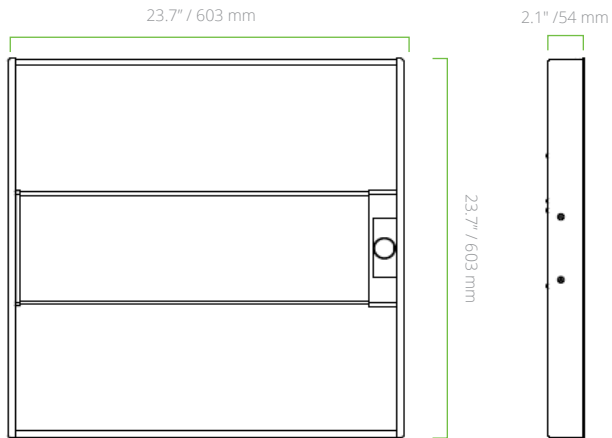

## 2X2 MODELS

Weight: 6.8 lbs / 3.1 kg

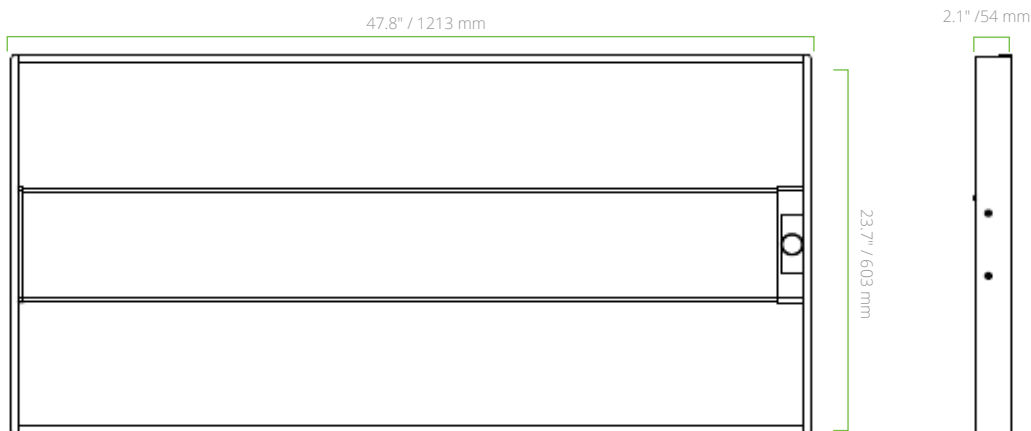

## 2X4 MODELS

Weight: 11.4 lbs / 5.2 kg