



# STR-R Linear Strip Retrofit

## HIGHLIGHTS

- Designed for easy installation on existing fluorescent strip fixtures, providing a quick update to the latest in LED performance without the need for all-new fixtures
- Available for 4' and 8' applications
- Designed for fixtures between 4.25" and 5.25" wide
- Up to 50% energy savings over fluorescent fixtures
- Up to 130 lm/W
- PowerSet feature allows for multiple "set and forget" lumen stops in each fixture
- FieldCCeT feature allows for multiple "set and forget" CCT options in each fixture

## CERTIFICATIONS

- UL Certified for US & Canada
- RoHS Compliant
- FCC Compliant
- ICES-005 Compliant
- Damp Location Certified
- DesignLights Consortium® Qualified - meets DLC requirements for efficacy and lumen maintenance

## PERFORMANCE

- High Efficacy, up to 130 lm/W
- Available in PowerSet models: power-selectable 44/35/27/22W or 88/68/54W
- Available in single CCT models: 3500K or 4000K or FieldCCeT models: field-selectable CCT 35/40/5000K
- CRI: >80
- Estimated L70: >100,000 Hours

## ELECTRICAL

- Input voltage: 120-277V
- 0-10V dimming, dim-to-off
- 12Vdc, 60mA power for controls
- Power Factor: >0.9
- THD: <20%

## THERMAL

- -22°F to 122°F (-30°C to 50°C) ambient operating temperature

## CONSTRUCTION

- Die-formed cold rolled steel with gloss white powder coated finish
- Extruded acrylic lens for uniform illumination and visual comfort

## WARRANTY

- 5 Year limited warranty available [online](#). Contact your EiKO sales rep for additional details.

project name	type
catalog number	voltage
approved by	date



STR4R



STR8R



## APPLICATIONS

- Storage areas
- Utility areas
- Coves
- Display cases
- Retail
- Task lighting
- General area lighting

## KEY FEATURES

### EASY INSTALLATION

Designed for easy installation on existing fluorescent strip fixtures, providing a quick update to the latest in LED performance without the need for all-new fixtures.

### POWERSET AND FIELDCCET

The PowerSet feature allows for multiple "set and forget" lumen stops in each fixture and the FieldCCeT feature allows for multiple "set and forget" CCT options in each fixture.

### MULTIPLE SIZES

Available in 4' and 8' applications.

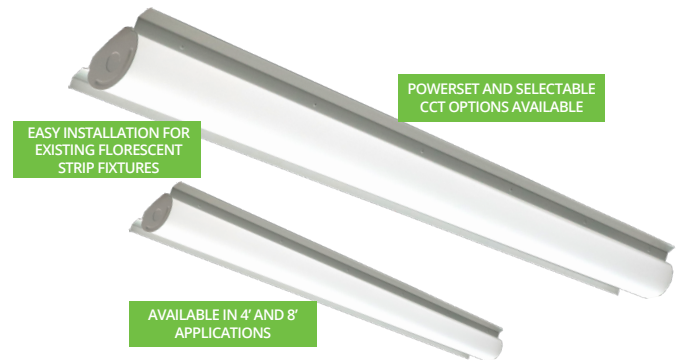

## AVAILABLE MODELS

ORDER	ORDER CODE	ITEM #	LENGTH	WATTS	CCT	LUMENS	EFFICACY (lm/W)	CRI	VOLTAGE	DIMMING	DLC
											STANDARD
	11362	STR4R/PS44/835/UD	4'	44/35/27/22W	3500K	5850/4550/3500/2850 lm	130 lm/W	>80	120-277V	0-10V	PP4W25PL
	11363	STR4R/PS44/840/UD	4'	44/35/27/22W	4000K	5850/4550/3500/2850 lm	130 lm/W	>80	120-277V	0-10V	PB691L52
	11364	STR4R/PS44/FCCT/UD	4'	44/35/27/22W	35/40/5000K	5850/4550/3500/2850 lm	130 lm/W	>80	120-277V	0-10V	PL10DLHO
	11365	STR4R/PS44/FCCT/HD	4'	44/35/27/22W	35/40/5000K	5850/4550/3500/2850 lm	130 lm/W	>80	120-347V	0-10V	PUHZ9W0L
	11366	STR8R/PS88/835/UD	8'	88/68/54W	3500K	11,400/8800/7000 lm	130 lm/W	>80	120-277V	0-10V	PTFA68IG
	11367	STR8R/PS88/840/UD	8'	88/68/54W	4000K	11,400/8800/7000 lm	130 lm/W	>80	120-277V	0-10V	PJGJY6FP
	11368	STR8R/PS88/FCCT/UD	8'	88/68/54W	35/40/5000K	11,400/8800/7000 lm	130 lm/W	>80	120-277V	0-10V	P1XGW0UI

## FACTORY INSTALLED OPTIONS

### BATTERY BACKUP

**[Blank]** : Default, no additional protection

**EM8W** : 8W Internal Backup battery, 120-277V

**EM15W** : 15W Internal Backup battery, 120-277V

**EM20W** : 20W Internal Backup battery, 120-277V

### MODEL CONFIGURATOR

### FACTORY INSTALLED OPTIONS

MODEL	SIZE	/	WATTS	/	CCT	/	VOLTAGE	-	BATTERY BACKUP
<b>STR</b>		/		/		/		-	

EXAMPLE PART NUMBER: STR4R/PS44/835/UD-EM8W

REFER TO FOLLOWING SECTIONS FOR DETAILS ON FACTORY INSTALLED OPTIONS & AVAILABLE FIELD INSTALLED OPTIONS

## BATTERY BACKUPS

ORDER	ORDER CODE	ITEM #	DESCRIPTION	FACTORY INSTALLED CODE
	10918	EEBN08WUA050	EiKO Emergency Battery Kit Internal 8W 120-277VAC 25-50VDC CEC Compliant. Factory or Field Installed Only.	EM8W
	10896	EEBN15WUA050	EiKO Emergency Battery Kit Internal 15W 120-277VAC 25-50VDC CEC Compliant. Factory or Field Installed Only.	EM15W
	10897	EEBN20WUA050	EiKO Emergency Battery Kit Internal 20W 120-277VAC 25-50VDC CEC Compliant. Factory or Field Installed Only.	EM20W

## CONTROLS & SENSORS: FIELD INSTALLED

ORDER	ORDER CODE	ITEM #	DESCRIPTION
<b>STANDALONE CONTROLS</b>			
<b>PIR SENSORS</b>			
	800654	MS2-OPD-3	Stand-alone PIR Motion Sensor, 120-347V, 1/2" knock-out, On/Off, Ambient Threshold, 40ft, Parameters set by dip switch. Order separately.
	800655	MS2-DPX-3	Stand-alone PIR Motion Sensor, 120-347V, 1/2" knock-out, 0-10V, Ambient Threshold, 40ft, Parameters set by dip switch or RC-100/SEN5A-ACT. Order separately.
	10220	SEN-3B-KO	Stand-alone PIR Motion Sensor, 120-277V, IP66, 1/2" knock-out, 0-10V, Ambient Threshold, 30ft, Parameters set by SEN-3-RC.
	9890	SEN-3A-KO	Stand-alone PIR Motion Sensor, 120-277V, IP66, 1/2" knock-out, On/Off, Ambient Threshold, 30ft, Parameters set by dip switch.
	10476	SEN-3AA-KO	Stand-alone PIR Motion Sensor, 120-277V, 1/2" knock-out, On/Off, Ambient Threshold, 30ft, Parameters set by dip switch.

## CONTROLS & SENSORS: FIELD INSTALLED CONT'D

ORDER	ORDER CODE	ITEM #	DESCRIPTION
<b>STANDALONE CONTROLS</b>			
<b>MICROWAVE SENSORS</b>			
	313895	MS1-DHR-KO-1	Stand-alone Microwave Motion Sensor, 120-277V, IP65, 1/2" knock-out, 0-10V, Ambient Threshold, 48ft, Parameters set by RC01.
	12150	SEN/M/S1C/KO	Stand-alone Microwave Motion Sensor, 120-277V, IP65 1/2" knock-out, 0-10V, Ambient Threshold, Parameters set by SEN-S1-RC3.
<b>REMOTES FOR COMMISSIONING STANDALONE CONTROLS</b>			
	13344	SEN5A-ACT	Commissioning Tool for SEN5A, BAY-E-SEN/PIR, BAY-E-SEN/M, and MS2-DPX-3 (Backward compatible with SEN5A/CT and RC-100).
	10226	SEN-3-RC	Commissioning Tool for SEN-3B-KO and SEN-3C-KO.
	313897	RC01	Commissioning Tool for MS1-DHR-SA-4, MS1-DHR-KO-1, MS1-DHR-KO-4.
	10917	SEN-S1-RC3	Commissioning Tool for SEN/M/S1C/KO.
<b>ADAPTERS &amp; ACCESSORIES</b>			
	12634	PSC-WCM-450-BLE-SR	BLE TruBlu Wireless Control Module, 120-277V, 16A Relay, 0-10V, 12V AUX 300mA, 100ft

## PRODUCT DIMENSIONS

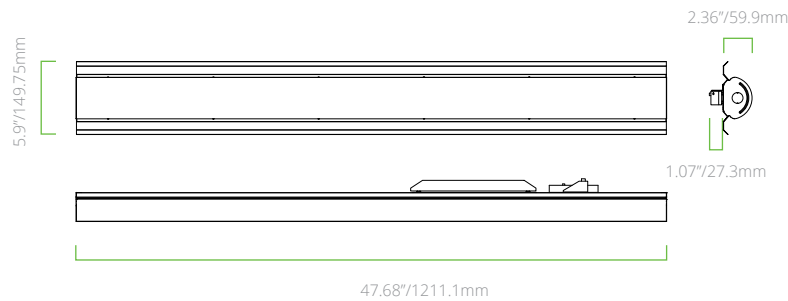

**STR4R**

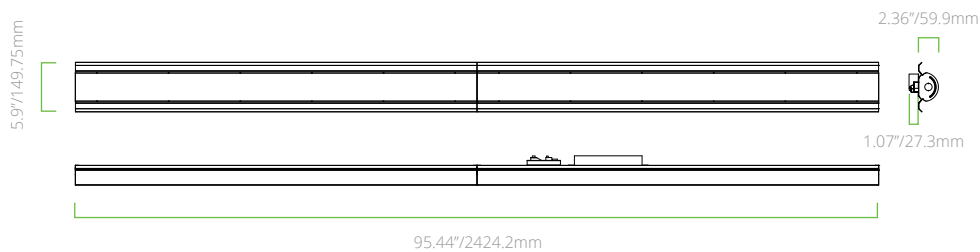

**STR8R**

\* The 8-foot STR retrofit kit is shipped in 4-foot sections.

## PHOTOMETRICS

**STR4R/PS44/840/UD** (Typical performance @44W, 4000K)

ZONAL LUMEN SUMMARY		
ZONE	LUMENS	%FIXTURE
0-30	1513.3	24.4%
0-40	2472.23	39.9%
0-60	4406.94	71.2%
0-80	5817.19	94.0%
0-90	6190.35	100%

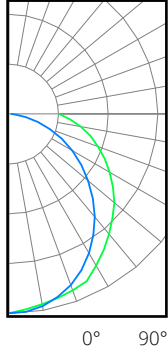

**STR4R/PS44/FCCT/UD** (Typical performance @44W, 4000K)

ZONAL LUMEN SUMMARY		
ZONE	LUMENS	%FIXTURE
0-30	1513.3	24.4%
0-40	2472.23	39.9%
0-60	4406.94	71.2%
0-80	5817.19	94.0%
0-90	6190.35	100%

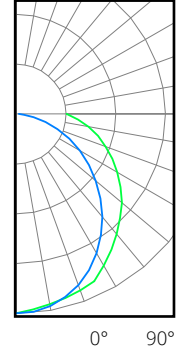

**STR8R/PS88/840/UD** (Typical performance @88W, 4000K)

ZONAL LUMEN SUMMARY		
ZONE	LUMENS	%FIXTURE
0-30	3127.49	25.0%
0-40	5109.02	40.9%
0-60	9087.93	72.7%
0-80	11839.24	94.8%
0-90	12492.53	100%

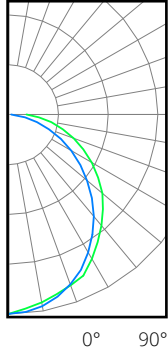

**STR8R/PS88/FCCT/UD** (Typical performance @88W, 4000K)

ZONAL LUMEN SUMMARY		
ZONE	LUMENS	%FIXTURE
0-30	3127.49	25.0%
0-40	5109.02	40.9%
0-60	9087.93	72.7%
0-80	11839.24	94.8%
0-90	12492.53	100%

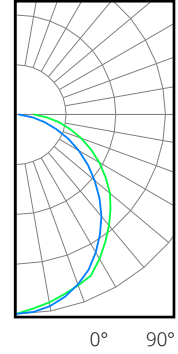

## SCALING FACTORS

FIXTURE	POWERSET		FIELDCCET			
	WATTS	3500K 4000K	3500K	4000K	5000K	
4'	44	1.00	0.95	1.00	0.97	
	35	0.85	0.80	0.83	0.82	
	27	0.64	0.62	0.64	0.63	
	22	0.51	0.49	0.50	0.49	
8'	88	1.00	0.93	1.00	0.97	
	68	0.76	0.72	0.76	0.75	
	54	0.60	0.57	0.59	0.59	