



LLH-E Linear High Bay

FEATURES

- 150 lpw ultra-high efficiency delivers superior performance over fluorescent and HID, saving up to 60% of energy costs
- Lumens: 9,750 - 57,000; 150 lumens per watt
- Multiple controls options, including 0-10V, occupancy sensors, and DLC Qualified Xi-Fi wireless mesh controls system.
- Standard Z10 receptacle simplifies adding controls

CERTIFICATIONS

- UL Listed for dry and damp locations
- DesignLights Consortium® Premium Qualified - meets the requirements for the highest DLC qualification for efficacy and lumen maintenance

PERFORMANCE

- Rated lifetime:
Reported L80 >54,000 hours @ 50°C
Reported L90 44,000 hours @ 50°C
Projected L70 150,000 hours @ 50°C
- 4000K, 5000K CCT
- CRI: >80
- UGR: <28

ELECTRICAL

- Input voltage: 120-277V; 277-480V
- 0-10V dimming to <10% with dim-to-off capability
- Power Factor: >.9
- THD: <20%
- Dimming sink current: 2mA
- Auxiliary Power: 12VDC, 200mA

THERMAL

- -22°F to 122°F (-30°C to 50°C) operating temperature

CONSTRUCTION

- Heavy gauge steel body with welded frame construction resists twisting and bowing
- Diffuse frosted acrylic lens to control glare (standard) or optional clear lens for higher light output (sold separately)
- 10 ft. Y-toggle aircraft cable mounting hardware included
- Built-in surge protection: 4kV (120-277V); 10kV (277-480V)

WARRANTY

- 5 year limited warranty. Additional warranty options available. Contact EiKO for details

project name	type
catalog number	voltage
approved by	date



RoHS Compliant



APPLICATIONS

- Warehouses
- Manufacturing Plants
- Distribution Centers
- Grocery Stores
- Gymnasiums
- Indoor Recreational Facilities
- Cold Storage
- Big Box Retail
- Service Repair Centers

CONFIGURATOR

MODEL	HOUSING	LUMEN PACKAGE	CRI/CCT	VOLTAGE	DIMMING	CONTROLS
LLH : Linear High Bay	1E - 1'x2'	65W - 65W; 9,750 lm 100W - 100W; 15,000 lm 130W - 130W; 19,500 lm 160W - 160W; 24,000 lm	840 - 80 CRI; 4000K 850 - 80 CRI; 5000K	U - 120-277V V - 277-480V	D - 0-10V Dimming	See page 2 for options
	2E - 1.5'x2'	200W - 200W; 30,000 lm				
	3E - 1'x4'	240W - 240W; 36,000 lm 300W - 300W; 45,000 lm				
	4E - 1.5'x4'	380W - 380W; 57,000 lm				

PERFORMANCE SUMMARY

ORDER CODE	ITEM #	LENGTH	WATTS	NOMINAL LUMENS	LPW	CCT	LENS	DIMMING	VOLTS	REPLACES	DLC PREMIUM
12480	LLH1E/65W/840/UD	2'	65W	9,750	150	4000K	Frosted	0-10V	120-277V	HBF 6x T8/4x T5	PBADU37J
12481	LLH1E/65W/850/UD	2'	65W	9,750	150	5000K	Frosted	0-10V	120-277V	HBF 6x T8/4x T5	PDOMWXNX
12138	LLH1E/100W/840/UD	2'	100W	15,000	150	4000K	Frosted	0-10V	120-277V	HBF 6x T8/4x T5	P45W5BFA
12139	LLH1E/100W/850/UD	2'	100W	15,000	150	5000K	Frosted	0-10V	120-277V	HBF 6x T8/4x T5	PZC3L5KS
12648	LLH1E/130W/840/UD	2'	130W	19,500	150	4000K	Frosted	0-10V	120-277V	HBF 8x T8/6x T5 HO	PDP3QZ7X
12649	LLH1E/130W/850/UD	2'	130W	19,500	150	5000K	Frosted	0-10V	120-277V	HBF 8x T8/6x T5 HO	PWTPQ9FR
12140	LLH1E/160W/840/UD	2'	160W	24,000	150	4000K	Frosted	0-10V	120-277V	HBF 8x T8/6x T5 HO	PF05IAK3
12141	LLH1E/160W/850/UD	2'	160W	24,000	150	5000K	Frosted	0-10V	120-277V	HBF 8x T8/6x T5 HO	PBUJ13K3
12142	LLH2E/200W/840/UD	2'	200W	30,000	150	4000K	Frosted	0-10V	120-277V	8x T5 HO	P6E38X1F
12143	LLH2E/200W/850/UD	2'	200W	30,000	150	5000K	Frosted	0-10V	120-277V	8x T5 HO	P6AZHZKA
12383	LLH3E/240W/840/UD	4'	240W	36,000	150	4000K	Frosted	0-10V	120-277V	10x T5 HO	P06D7FS6
12384	LLH3E/240W/850/UD	4'	240W	36,000	150	5000K	Frosted	0-10V	120-277V	10x T5 HO	PQ0BWFEGH
12385	LLH3E/300W/840/UD	4'	300W	45,000	150	4000K	Frosted	0-10V	120-277V	1000W HID	P6XJDHZ0
12386	LLH3E/300W/850/UD	4'	300W	45,000	150	5000K	Frosted	0-10V	120-277V	1000W HID	POQKMM4W
12482	LLH4E/380W/840/UD	4'	380W	57,000	150	4000K	Frosted	0-10V	120-277V	1000W HID	P3IEURTY
12483	LLH4E/380W/850/UD	4'	380W	57,000	150	5000K	Frosted	0-10V	120-277V	1000W HID	PT1UAD94
12368	LLH1E/100W/840/VD	2'	100W	15,000	150	4000K	Frosted	0-10V	277-480V	HBF 6x T8/4x T5	PEP0I8D3
12369	LLH1E/100W/850/VD	2'	100W	15,000	150	5000K	Frosted	0-10V	277-480V	HBF 6x T8/4x T5	PDW18TUR
12370	LLH1E/160W/840/VD	2'	160W	24,000	150	4000K	Frosted	0-10V	277-480V	HBF 8x T8/6x T5 HO	PYH2ZW14
12371	LLH1E/160W/850/VD	2'	160W	24,000	150	5000K	Frosted	0-10V	277-480V	HBF 8x T8/6x T5 HO	PT3ZI0HJ
12372	LLH2E/200W/840/VD	2'	200W	30,000	150	4000K	Frosted	0-10V	277-480V	8x T5 HO	P2CF7ESZ
12373	LLH2E/200W/850/VD	2'	200W	30,000	150	5000K	Frosted	0-10V	277-480V	8x T5 HO	PUZAV5A8
12374	LLH3E/240W/840/VD	4'	240W	36,000	150	4000K	Frosted	0-10V	277-480V	10x T5 HO	PCCL2LGH
12375	LLH3E/240W/850/VD	4'	240W	36,000	150	5000K	Frosted	0-10V	277-480V	10x T5 HO	P9G26QHV
12376	LLH3E/300W/840/VD	4'	300W	45,000	150	4000K	Frosted	0-10V	277-480V	1000W HID	PAR08VKE
12377	LLH3E/300W/850/VD	4'	300W	45,000	150	5000K	Frosted	0-10V	277-480V	1000W HID	PJDZ22LK
12378	LLH4E/380W/840/VD	4'	380W	57,000	150	4000K	Frosted	0-10V	277-480V	1000W HID	PI6D50DJ
12379	LLH4E/380W/850/VD	4'	380W	57,000	150	5000K	Frosted	0-10V	277-480V	1000W HID	P1G0D51R

ACCESSORIES

ORDER CODE	ITEM #	DESCRIPTION
12387	LLH1E-WG	Wire Guard for LLH1E
12388	LLH2E-WG	Wire Guard for LLH2E
12389	LLH3E-WG	Wire Guard for LLH3E
12390	LLH4E-WG	Wire Guard for LLH4E
12391	LLHE-PMK	LLH-E Pendant Mount Kit for LLH1E, LLH2E, LLH3E, LLH4E
12392	LLHE-SMK1	LLH-E Surface Mount Kit for LLH1E, LLH3E
12393	LLHE-SMK2	LLH-E Surface Mount Kit for LLH2E, LLH4E

SIZE EQUIVALENT*

LLH-DX SERIES	NOMINAL FIXTURE SIZE	LLH1E	LLH2E	LLH3E	LLH4E
LLH-06DX/1DX/2DX	1 x 2	✓			
LLH-3DX	1.5 X 2		✓		
LLH-4DX/5DX	1 x 4			✓	
LLH-7DX	1.5 x 4				✓

*For general reference only, LLH-E fixtures are not compatible with accessories from previous models.

LUMEN EQUIVALENT

LLH-DX SERIES	LLH1E/ 100W	LL1E/ 160W	LLH2E/ 200W	LLH3E/ 240W	LLH3E/ 300W	LLH4E/ 380W
LLH-1DX	✓					
LLH-2DX		✓				
LLH-3DX			✓			
LLH-4DX				✓		
LLH-5DX					✓	
LLH-7DX						✓

BATTERY BACKUPS

ORDER	ORDER CODE	ITEM #	DESCRIPTION	FACTORY INSTALLED CODE
	11675	EEBE18WHA170S*	EiKO Emergency Battery External 18W 100-347V 170VDC Single Flex-Conduit CEC Compliant. Factory or field install. See spec sheet for full details. Note: Suitable ONLY for 100-347V 90W & 130W fixtures.	EB18
	13574	EEBE40WHA170S*	EiKO Emergency Battery External 40W 100-347VAC 170VDC Linear Single Flex-Conduit CEC Compliant. Factory or field install. See spec sheet for full details. Note: In EM mode, only half of the 440W fixture will power up.	EB40
	10920	EEBE30WUA050S	EiKO Emergency Battery External 30W 120-277VAC 25-50VDC CEC Compliant	EB30

***WARNING:** When using these AC version battery backups with any control solution, internal rewiring is required according to the installation sheet's wiring diagram. Failure to do so may result in a violation of safety codes.

CONTROLS & SENSORS: FIELD INSTALLED

ORDER	ORDER CODE	ITEM #	DESCRIPTION
STANDALONE CONTROLS			
PIR SENSORS			
	800654	MS2-OPD-3	Stand-alone PIR Motion Sensor, 120-347V, 1/2" knock-out, On/Off, Ambient Threshold, 40ft, Parameters set by dip switch.
	800655	MS2-DPX-3	Stand-alone PIR Motion Sensor, 120-347V, 1/2" knock-out, 0-10V, Ambient Threshold, 40ft, Parameters set by dip switch, RC-100 or SEN5A-ACT.
	10220	SEN-3B-KO	Stand-alone PIR Motion Sensor, 120-277V, IP66, 1/2" knock-out, 0-10V, Ambient Threshold, 30ft, Parameters set by SEN-3-RC.
	10476	SEN-3AA-KO	Stand-alone PIR Motion Sensor, 120-277V, 1/2" knock-out, On/Off, Ambient Threshold, 30ft, Parameters set by dip switch.
	13342	SEN5A-SZPR-WH	Stand-alone PIR Motion Sensor, 12-24V, Z10, 0-10V, Daylight Harvesting, 8-40ft, White, IP65, Parameters set by SEN5A-ACT.
MICROWAVE SENSORS*			
	313895	MS1-DHR-KO-1	Stand-alone Microwave Motion Sensor, 120-277V, IP65, 1/2" knock-out, 0-10V, Ambient Threshold, 48ft, Parameters set by RC01.
	12150	SEN/M/S1C/KO	Stand-alone Microwave Motion Sensor, 120-277V, IP65 1/2" knock-out, 0-10V, Ambient Threshold, Parameters set by SEN-S1-RC3.
	13341	SEN5A-SZMR-WH	Stand-alone Microwave Motion Sensor, 12-24V, Z10, 0-10V, Daylight Harvesting, 40ft, White, Parameters set by SEN5A-ACT.

* Microwave sensors must be installed on stable and immovable fixtures to avoid false activation from swinging.

REMOTES FOR COMMISSIONING STANDALONE CONTROLS			
	13344	SEN5A-ACT	Commissioning Tool for SEN5A, BAY-E-SEN/PIR, BAY-E-SEN/M, and MS2-DPX-3. (Backward compatible with SEN5A/CT and RC-100)
	10226	SEN-3-RC	Commissioning Tool for SEN-3B-KO and SEN-3C-KO.
	313897	RC01	Commissioning Tool for MS1-DHR-SA-4, MS1-DHR-KO-1, MS1-DHR-KO-4.
	10917	SEN-S1-RC3	Compatible with SEN/M/S1C/KO.

ORDER	ORDER CODE	ITEM #	DESCRIPTION
NETWORKED LIGHTING CONTROLS (NLC)			
SENSOR AND CONTROLLER			
	13246	SENA-WZPA-WH	BLE PIR Motion sensor, 12-24V, IP65, Z10, 0-10V, Daylight Harvesting, 40ft, Parameters set by Silvoir App.
	12643	PSC-ZKV-WCM-100-BLE-SR	BLE TruBLE wireless fixture Controller, 12-24V, Z10, 0-10V, Parameters set by Silvoir App.
WALL OR WIRELESS CONTROLLERS			
	12654	ESRPB-W-EO	BLE Easyfit by EnOcean wireless self-powered kinetic Single rocker pad, white, wall plate included.
	12655	EDRPB-W-EO	BLE Easyfit by EnOcean wireless self-powered kinetic Double rocker pad, white, wall plate included.
	12635	PSC-DM-WS-100-BLE-SR	BLE TruBlu 120-277V, Single Gang Single Button Wall Controller, White, Parameters set by Silvoir App.
	12636	PSC-DM-I-WS-100-BLE-SR	BLE TruBlu PIR Occupancy/ Vacancy Sensor, 120-277V, Single Gang Wall Controller, White, Parameters set by Silvoir App.
	12637	PSC-DM-WS-400-BLE-SR	BLE TruBlu 4-Button Wall Controller, 120-277V, Single Gang, White, Parameters set by Silvoir App.
ADAPTERS & ACCESSORIES			
	12994	PSC-RET-100-BLE-SR	BLE TruBlu Range Extender, 120-277V, 800ft, Nema 4X Outdoor Enclosure
	12993	PSC-TKP-200-BLE-SR	BLE TruBlu Battery Backup Timekeeper and Range Extender, 120V, 800ft, Nema 4X Outdoor Enclosure
	13234	SGW-101	BLE Silvoir Gateway SGW-101 Manufactured by Rigado (model: Cascade-500). 5-year from Silvoir warranty and tech support.

PRODUCT DIMENSIONS

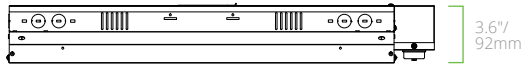
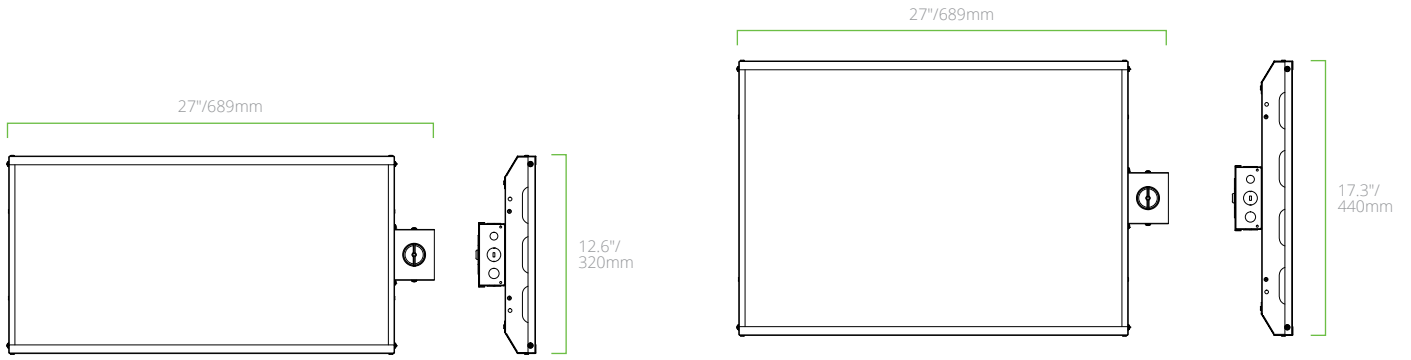

LLH1E Z10 Receptacle

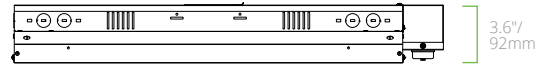

LLH2E Z10 Receptacle

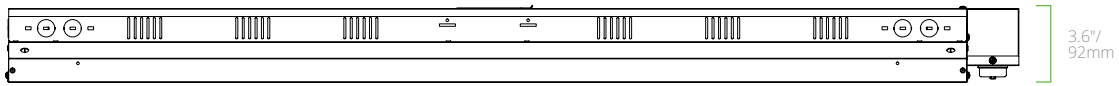
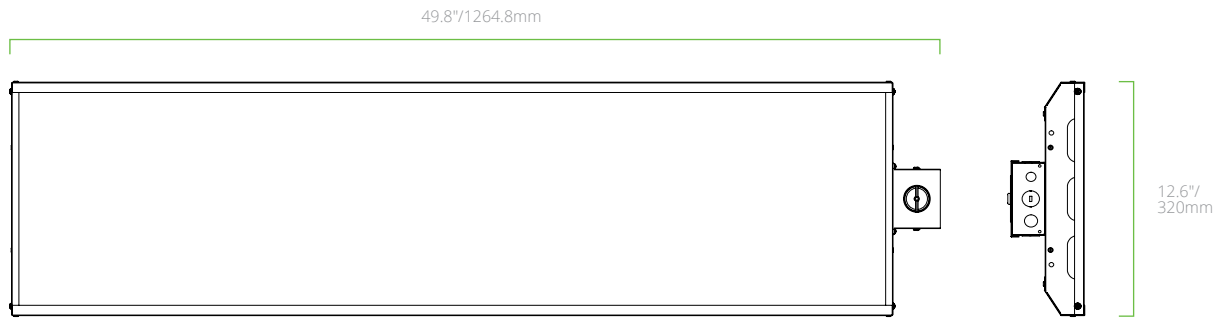

LLH3E

Z10 Receptacle

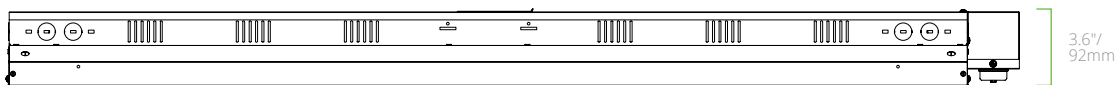
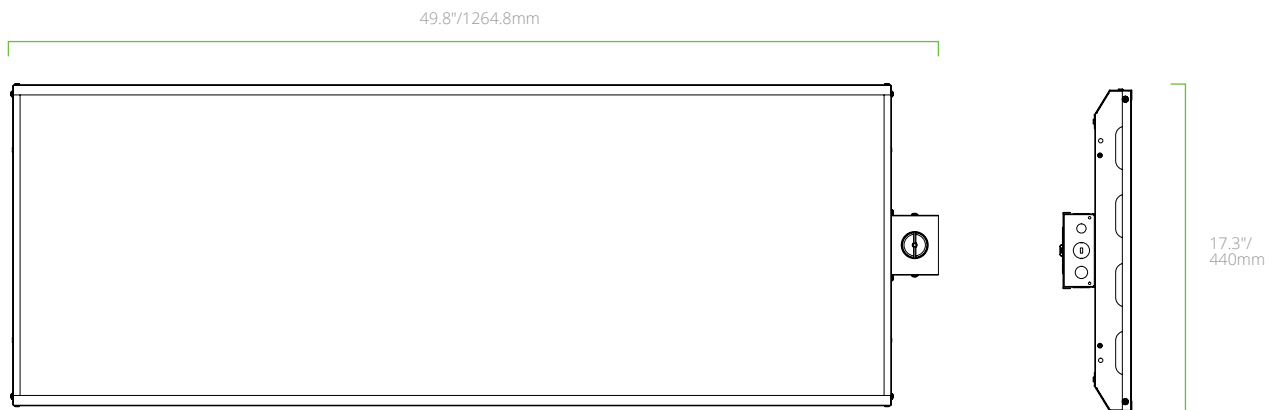

LLH4E

Z10 Receptacle

PHOTOMETRICS

LLH1E/100W (Typical performance @ 5000K)

ZONAL LUMEN SUMMARY		
ZONE	LUMENS	%FIXTURE
0-30	4395.11	29.7%
0-40	7061.17	47.8%
0-60	11966.29	81%
0-80	14516.74	98.2%
0-90	14780.68	100%
60-80	2550.44	17.3%
70-80	898.68	6.1%
80-90	263.94	1.8%

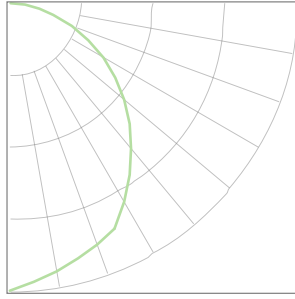

LLH1E/160W (Typical performance @ 5000K)

ZONAL LUMEN SUMMARY		
ZONE	LUMENS	%FIXTURE
0-30	7022.92	29.6%
0-40	11310.82	47.7%
0-60	19238.84	81.1%
0-80	23289.51	98.1%
0-90	23735.02	100%
60-80	4050.67	17.1%
70-80	1408.31	5.9%
80-90	445.51	1.9%

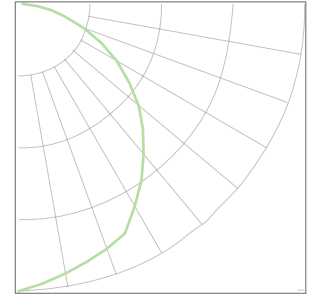

LLH2E/200W (Typical performance @ 5000K)

ZONAL LUMEN SUMMARY		
ZONE	LUMENS	%FIXTURE
0-30	8518.34	29.8%
0-40	13705.25	47.9%
0-60	23238.64	81.3%
0-80	28066.08	98.2%
0-90	28591.10	100%
60-80	4827.44	16.9%
70-80	1674.06	5.9%
80-90	525.02	1.8%

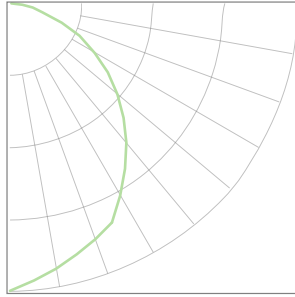

LLH3E/240W (Typical performance @ 5000K)

ZONAL LUMEN SUMMARY		
ZONE	LUMENS	%FIXTURE
0-30	11704.39	32.8%
0-40	18757.67	52.5%
0-60	30140.98	84.4%
0-80	35158.36	98.4%
0-90	35723.38	100%
60-80	5017.38	14%
70-80	1755.29	4.9%
80-90	565.02	1.6%

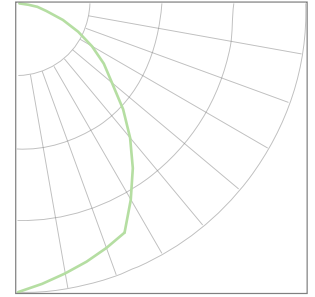

LLH3E/300W (Typical performance @ 5000K)

ZONAL LUMEN SUMMARY		
ZONE	LUMENS	%FIXTURE
0-30	14875.06	32.4%
0-40	23908.58	52.1%
0-60	38610.43	84.2%
0-80	45129.54	98.4%
0-90	45873.12	100%
60-80	6519.11	14.2%
70-80	2280.9	5%
80-90	743.58	1.6%

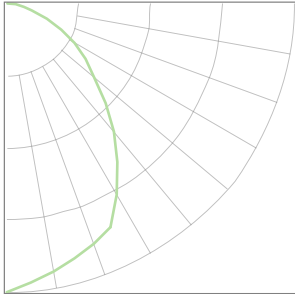

LLH4E/380W (Typical performance @ 5000K)

ZONAL LUMEN SUMMARY		
ZONE	LUMENS	%FIXTURE
0-30	17880.95	31.8%
0-40	28835.10	51.2%
0-60	47051.76	83.6%
0-80	55314.68	98.2%
0-90	56306.43	100%
60-80	8262.92	14.7%
70-80	2906.06	5.2%
80-90	991.75	1.8%

