

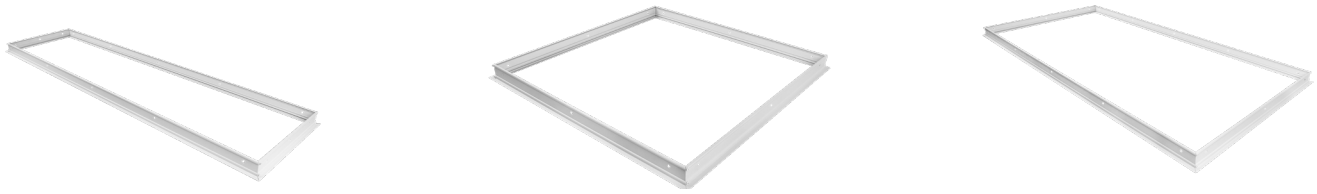





INSTALLATION INSTRUCTIONS

Recessed Mounting Kit For Flat Panels and Troffers



OVERVIEW

WHAT'S IN THE BOX

Item	Picture	Quantity
Drywall flange kit A		1'x4' (2pcs)
Drywall flange kit B		2'x2'(4pcs) / 2'x4' (2pcs)
Drywall flange kit C		1'x4'(2pcs) / 2'x4'(2pcs)
ST3*12 Wafer Head Self Tapping Screw		8pcs + 1pcs spare screw
SR4.2*30 Countersunk head self tapping		2'x2' (12pcs + 1pcs spare screw) 1'x4' (16pcs + 1pcs spare screw) 2'x4' (16pcs + 1pcs spare screw)
Anchor		2'x2' (12pcs + 1pcs spare anchor) 1'x4' (16pcs + 1pcs spare anchor) 2'x4' (16pcs + 1pcs spare anchor)

WHAT YOU'LL NEED

- #2 Phillips screwdriver
- Safety glasses

IMPORTANT

Before installing fixture, read all instructions and retain for future reference. The important instructions and safeguards that appear in this document are not inclusive of all possible conditions and situations that may occur. It must be understood that common sense, caution, and care are factors that cannot be built into a product. These factors must be supplied by those that care and operate the fixture.

Consider a qualified licensed electrician for installation.

For additional information required not covered in this document please contact a local representative.

FIXTURE COMPATIBILITY

- BP1
- EP1
- FPH3
- VL1
- VOL

FRAME SIZE

1X4

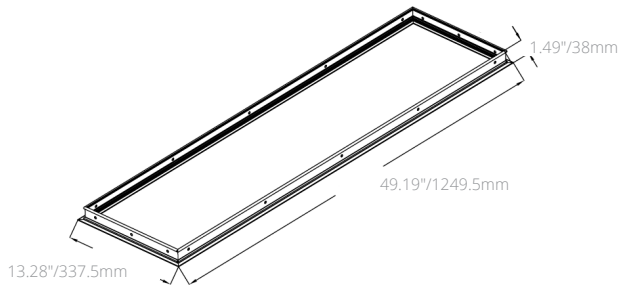
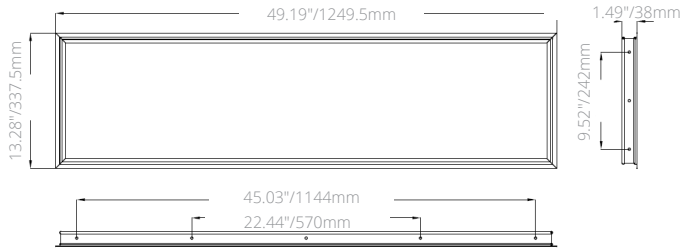

2X2

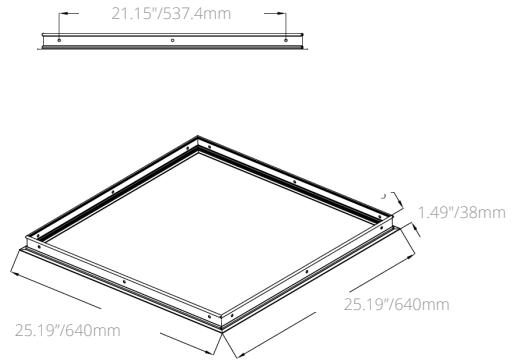
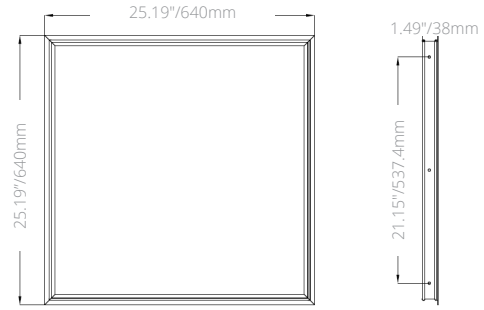

2X4

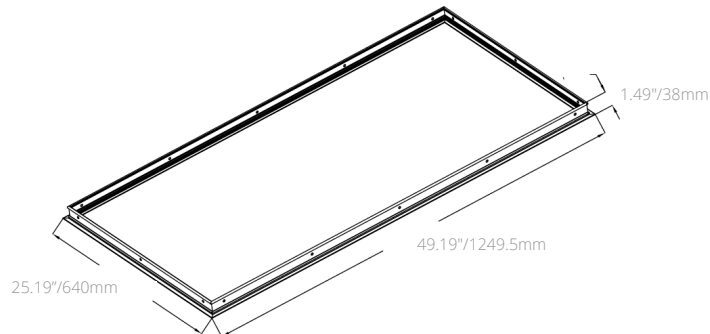
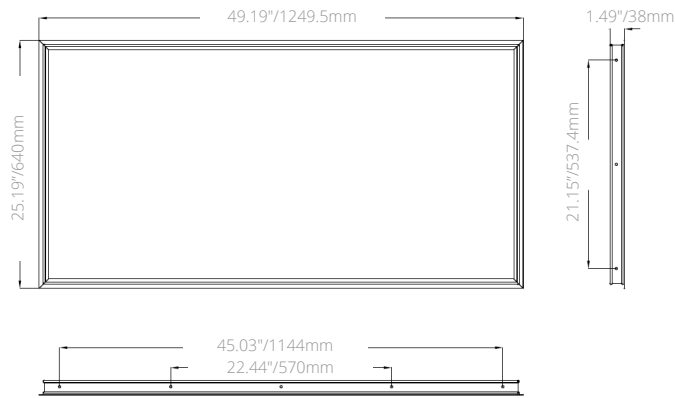

INSTALLATION INSTRUCTIONS

ALWAYS TURN OFF THE POWER SUPPLY FROM MAIN CIRCUIT BREAKER FIRST!

SIZE	CUT-OUT SIZE
1'x4'	48.66"(1236mm) x 12.76" (324mm)
2'x2'	24.61 (625mm) x 24.61 (625mm)
2'x4'	48.66 (1236mm) x 24.41 (620mm)

1 Gently remove the accessories from the package. Assemble the four drywall flange kits using the provided ST3.12 Wafer Head Self Tapping Screws. (Refer to Fig 1).

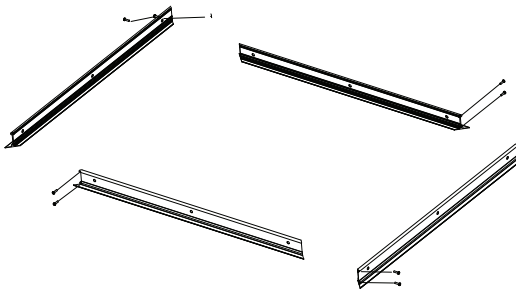

Figure 1

2 Position the assembled drywall flange kits into their holes and secure them using the ST4.2*30 Countersunk Head Self-Tapping Screws. (See Fig 2).

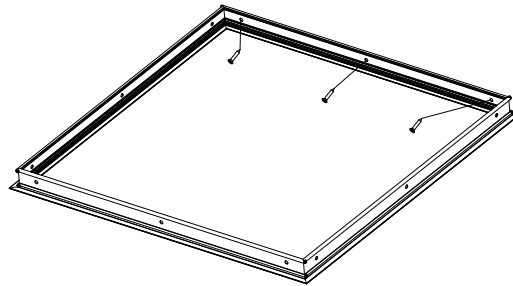

Figure 2

3 Put the lamp into the flange kit, connect the input lines, and the installation is done. (Refer to Fig 3).

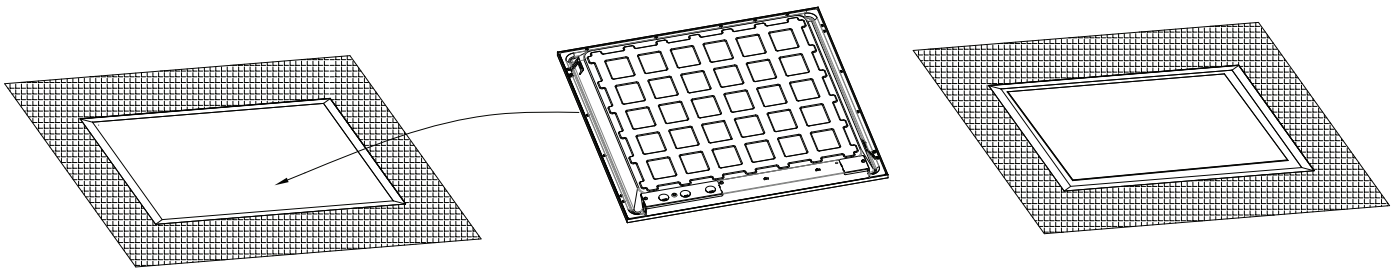
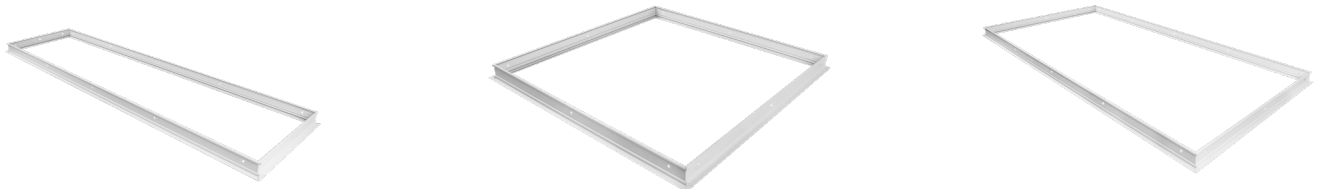

Figure 3







INSTRUCTIONS D'INSTALLATION

Trousse de montage encastré pour panneaux plats et chemins lumineux



VUE D'ENSEMBLE

CE QUE CONTIENT LA BOÎTE

Pièce	Image	Quantité
Ensemble de brides pour cloisons sèches A		30 cm x 122 cm/1 pi x 4 pi (2 pièces)
Ensemble de brides pour cloisons sèches B		61 cm x 61 cm/2 pi x 2 pi (4 pièces) 61 cm x 122 cm/2 pi x 4 pi (2 pièces)
Ensemble de brides pour cloisons sèches C		30 cm x 122 cm/1 pi x 4 pi (2 pièces) 61 cm x 122 cm/2 pi x 4 pi (2 pièces)
Vis autotaraudeuses à tête plate ST3*12		8 vis + 1 vis de rechange
Vis autotaraudeuses à tête fraisée SR4.2* 30		61 cm x 61 cm/2 pi x 2 pi (12 vis + 1 vis de rechange) 30 cm x 122 cm/1 pi x 4 pi (16 vis + 1 vis de rechange) 61 cm x 122 cm/2 pi x 4 pi (16 vis + 1 vis de rechange)
Pièce d'ancrage		61 cm x 61 cm/2 pi x 2 pi (12 ancrages + 1 ancrage de rechange) 30 cm x 122 cm/1 pi x 4 pi (16 ancrages + 1 ancrage de rechange) 61 cm x 122 cm/2 pi x 4 pi (16 ancrages + 1 ancrage de rechange)

CE DONT VOUS AUREZ BESOIN

- Tournevis Phillips n° 2
- Lunettes de sécurité

IMPORTANT

Avant d'installer le luminaire, lire toutes les instructions et les conserver pour consultation ultérieure. Les instructions et les mesures de protection importantes contenues dans ce document n'incluent pas toutes les conditions et situations pouvant survenir. Il importe de comprendre que le bon sens, la prudence et la précaution sont des qualités qui ne sont pas inhérentes au produit. Il revient aux personnes qui manipulent le luminaire d'en faire preuve.

L'installation doit être confiée à un électricien qualifié et agréé.

Pour toute information supplémentaire requise et non couverte par ce document, veuillez contacter un représentant local.

COMPATIBILITÉ DES LUMINAIRES

- BP1
- EP1
- FPH3
- VL1
- VOL

DIMENSIONS DES CADRES

30 CM X 122 CM (1 PI X 4 PI)

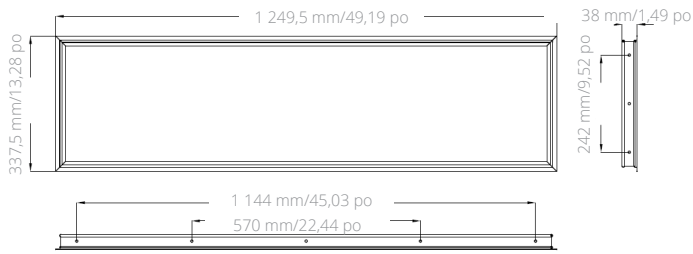

61 CM X 61 CM (2 PI X 2 PI)

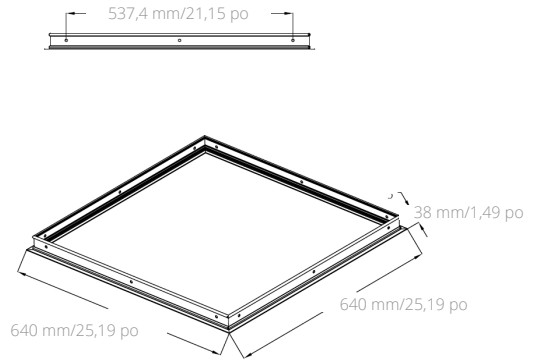
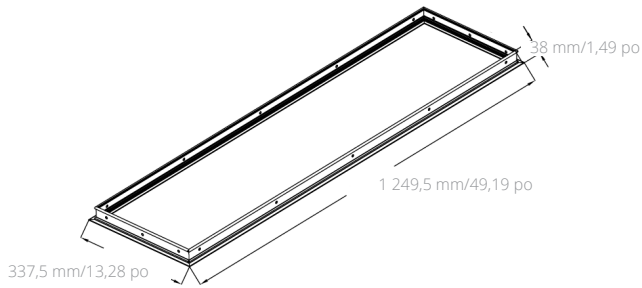
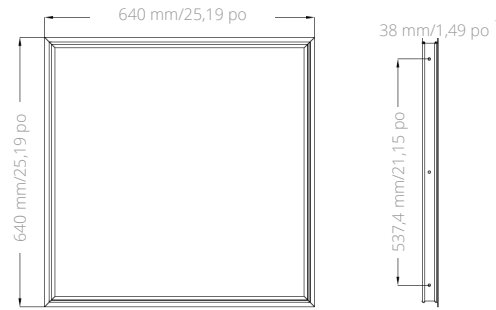

61 CM X 122 CM (2 PI X 4 PI)

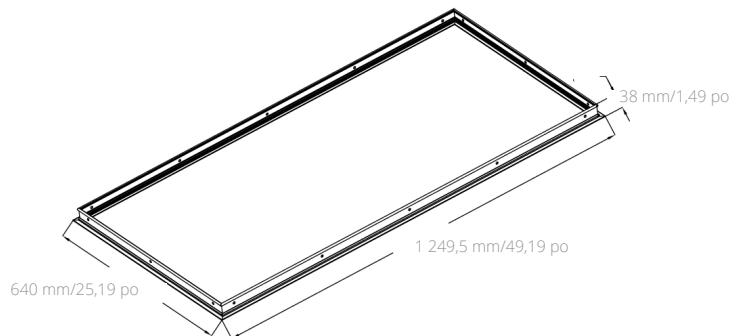
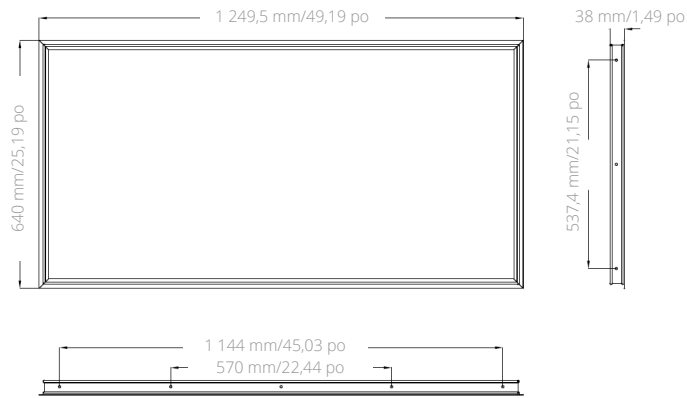

INSTRUCTIONS D'INSTALLATION

AVANT TOUTE CHOSE, TOUJOURS COUPER L'ALIMENTATION ÉLECTRIQUE DU DISJONCTEUR PRINCIPAL!

DIMENSIONS	TAILLE DE DÉCOUPE
30 cm x 122 cm (1 pi x 4 pi)	1 236 mm (48,66 po) x 324 mm (12,76 po)
61 cm x 61 cm (2 pi x 2 pi)	625 mm (24,61 po) x 625 mm (24,61 po)
61 cm x 122 cm (2 pi x 4 pi)	1 236 mm (48,66 po) x 620 mm (24,41 po)

1 Retirer délicatement les accessoires de l'emballage. Assembler les quatre ensembles de brides pour cloisons sèches à l'aide des vis autotaraudeuses à tête plate ST3.12 fournies. (Voir figure 1.)

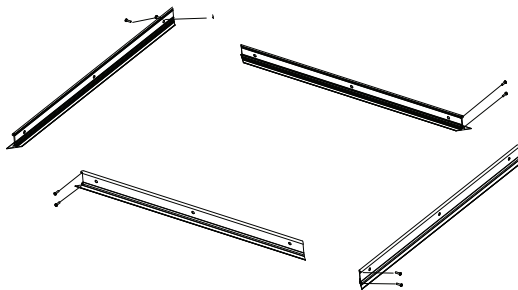

Figure 1

2 Placer les ensembles de brides pour cloisons sèches assemblés dans leurs trous et les fixer à l'aide des vis autotaraudeuses à tête fraisée ST4.2* 30. (Voir figure 2.)

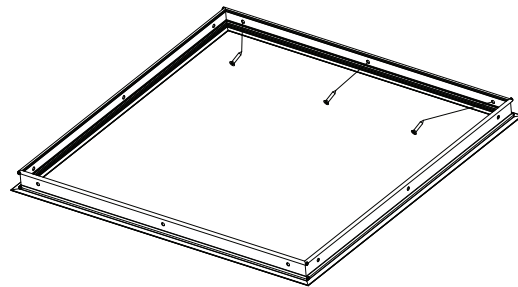

Figure 2

3 Placer le panneau lumineux dans l'ensemble de brides et connecter les lignes d'entrée. L'installation est alors terminée. (Voir figure 3.)

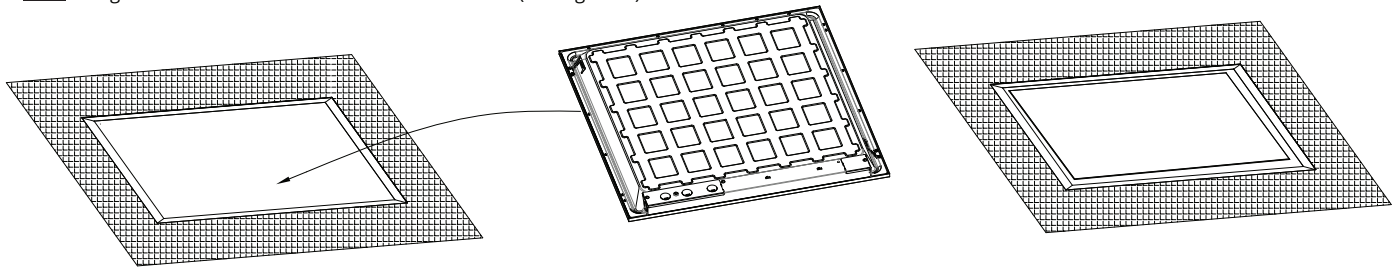
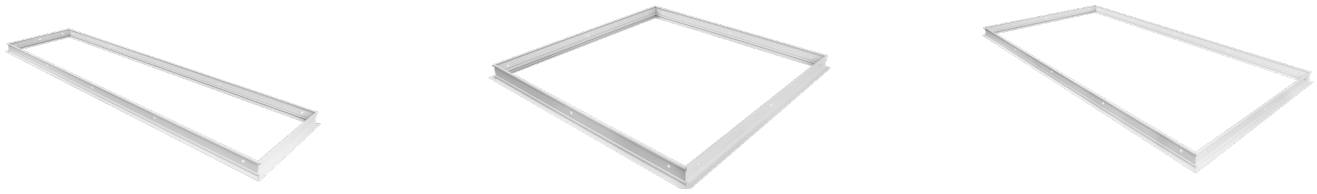

Figure 3







INSTRUCCIONES DE INSTALACIÓN

Conjunto de montaje empotrado para paneles planos y deflectores



VISIÓN GENERAL

QUÉ HAY EN LA CAJA

Elemento	Imagen	Cantidad
Conjunto de bridas para tabiquería seca A		1'x4' (2 piezas)
Conjunto de bridas para tabiquería seca B		2'x2' (4 piezas) / 2'x4' (2 piezas)
Conjunto de bridas para tabiquería seca C		1'x4' (2 piezas) / 2'x4' (2 piezas)
Tornillo autorroscante de cabeza oblea ST3*12		8 piezas + 1 tornillo de repuesto
Tornillo autorroscante de cabeza ovalada SR4.2*30		2'x2' (12 piezas + 1 tornillo de repuesto) 1'x4' (16 piezas + 1 tornillo de repuesto) 2'x4' (16 piezas + 1 tornillo de repuesto)
Anclaje		2'x2' (12 piezas + 1 anclaje de repuesto) 1'x4' (16 piezas + 1 anclaje de repuesto) 2'x4' (16 piezas + 1 anclaje de repuesto)

LO QUE NECESITA

- Destornillador Phillips N° 2
- Gafas de seguridad

IMPORTANTE

Antes de instalar el artefacto, lea todas las instrucciones y consérvelas para futuras consultas. Las instrucciones y precauciones importantes que aparecen en este documento no incluyen todas las condiciones y situaciones posibles que pueden ocurrir. Se debe entender que el sentido común, la precaución y el cuidado son factores que no se pueden incorporar a un producto. Estos factores deben ser asumidos por quienes cuidan y operan el artefacto.

Pida a un electricista calificado que realice la instalación.

Para obtener información adicional, no incluida en este documento, puede contactar a su representante local.

COMPATIBILIDAD DE LAS LUMINARIAS

- BP1
- EP1
- FPH3
- VL1
- VOL

TAMAÑO DEL MARCO

1X4

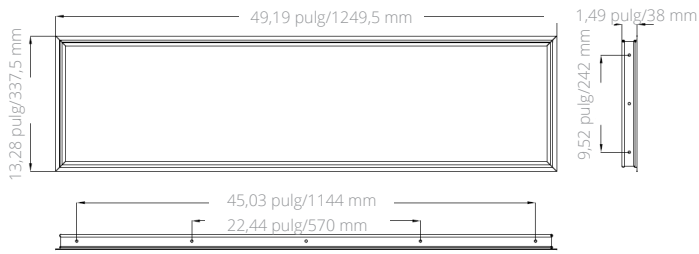

2X2

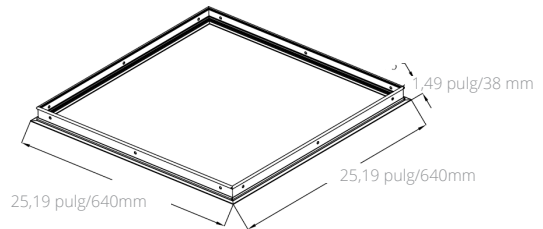
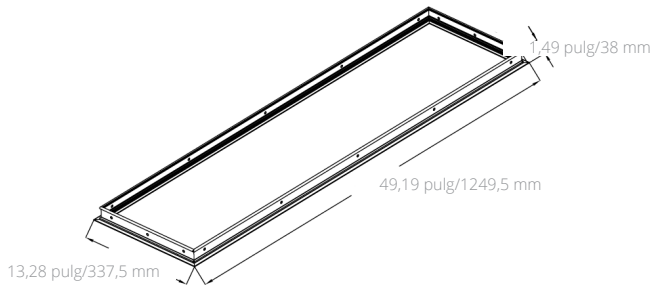
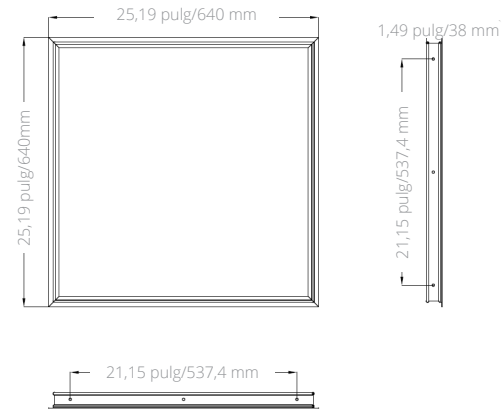

2X4

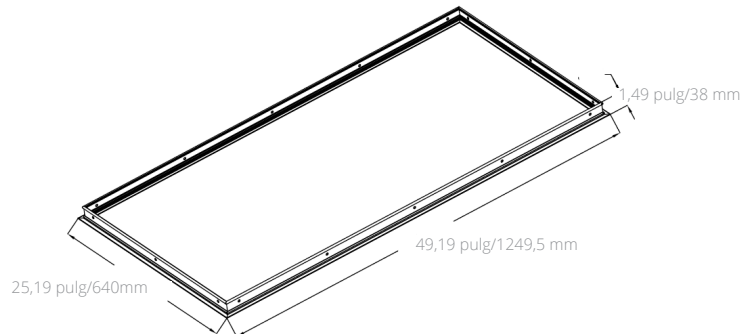
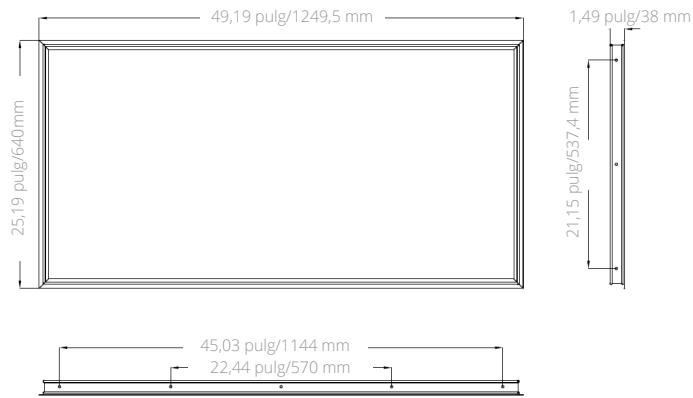

INSTRUCCIONES DE INSTALACIÓN

ANTES DE COMENZAR, ¡SIEMPRE DESCONECTE EL SUMINISTRO DE ENERGÍA DEL INTERRUPTOR PRINCIPAL!

TAMAÑO	TAMAÑO DEL RECORTE
1'x4'	48,66 pulg (1236 mm) x 12,76 pulg (324 mm)
2'x2'	24,61(625 mm) x 24,61 (625 mm)
2'x4'	48,66 (1236 mm) x 24,41 (620 mm)

1 Con cuidado, retire los accesorios del embalaje. Ensamble los cuatro conjuntos de bridas para paneles de yeso, utilizando los tornillos autorroscantes de cabeza oblea ST3.12 suministrados. (Consulte la figura 1).



Figura 1

2 Coloque los conjuntos de bridas para paneles de yeso ensamblados en sus orificios y fíjelos con los tornillos autorroscantes de cabeza ovalada ST4.2*30. (Consulte la figura 2).



Figura 2

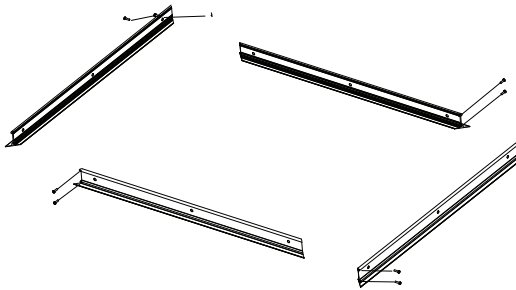

3 Coloque la luminaria en el conjunto de brida, conecte las líneas de entrada y la instalación estará terminada. (Consulte la figura 3).

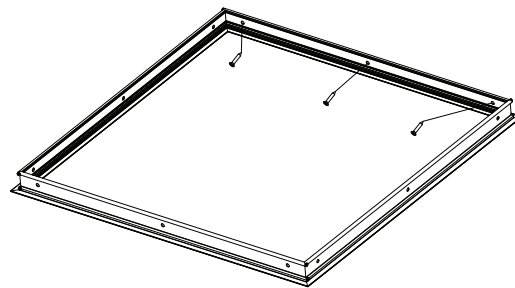
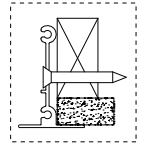
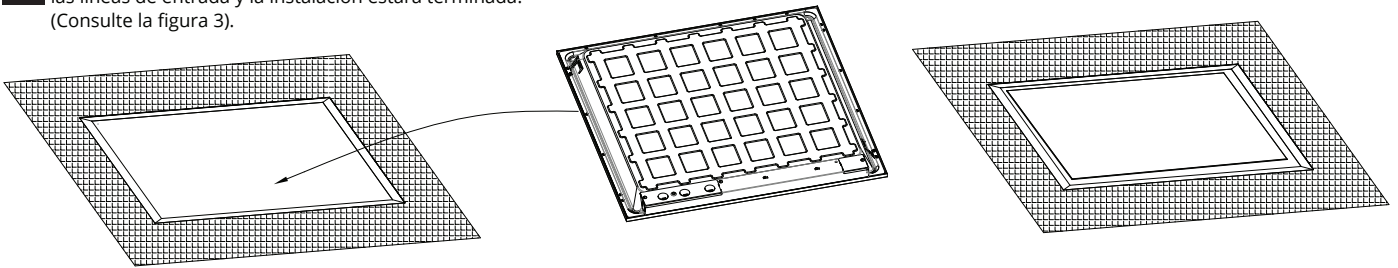

Figura 3