



## T8 Type C LED T8 Lamps and Drivers

### HIGHLIGHTS

- Type C lamps offer superior efficacy compared to other types of LED tubes
- Type C drivers feature adjustable current outputs, making them compatible with a wide range of Type C tubes and providing flexibility to meet various lighting requirements and configurations
- Instantaneous full light output upon power-up
- Glass material for better light transmission
- Dimmable with 0-10V dimmer

### CERTIFICATIONS

- ETL
- FCC Compliant
- RoHS Compliant
- ICES-005 Compliant
- Damp Location
- **Pending** DesignLights Consortium® Qualified - meets DLC requirements for efficacy and lumen maintenance

### PERFORMANCE

- High efficacy, up to 162 lm/W
- Available in single CCT models: 3500, 4000, or 5000K
- Adjustable current output drivers
- CRI: 83
- Rated Life: >50,000 hours

### ELECTRICAL

- Drivers: 120-277VAC (input), 48VDC (output)
- Lamps: 48VDC
- Driver Surge protection: 2.5kV
- Power Factor: >0.9
- THD: <20%

### THERMAL

- -4°F to 113°F (-20°C to 45°C) operating temperature
- Not recommended for air-tight fixtures

### CONSTRUCTION

- Available in 2', 3', 4' and U-bend
- Frosted glass lens provides optimal heat dissipation
- G13 bi-pin

### WARRANTY

- 5-Year limited warranty available [online](#). Contact your EiKO sales rep for additional details.

project name	type
catalog number	voltage
approved by	date

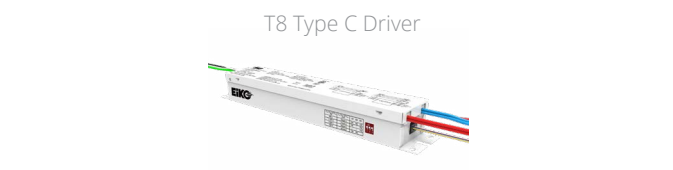
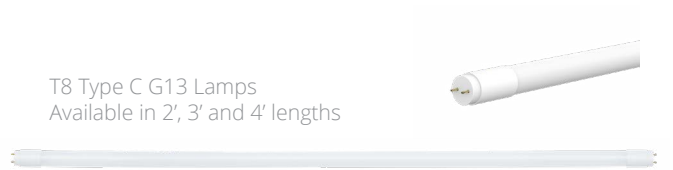

### APPLICATIONS

- Office
- Hospital
- Classroom
- Hotel
- Retail
- Warehouse
- Stairwell
- Hallway
- Production
- Gym
- Campus

### MODEL CONFIGURATOR

MODEL	WATTAGE	TUBE SIZE	TUBE LENGTH	TYPE	WIRING	MATERIAL	CCT
L : LED	9W - 9W	T8 - T8	24 - 2ft	C - Type C	D - Double-ended	G - Glass	35K - 3500K 40K - 4000K 50K - 5000K
	11.5W - 11.5W		36 - 3ft				
	13.5W - 13.5W		48 - 4ft				
	15W - 15W		U1 - 1-5/8"				
			U6 - 6"				

## AVAILABLE MODELS

ORDER	ORDER CODE	ITEM #	WATTS	LUMENS	CCT*	EFFICACY (lm/W)	INPUT VOLTAGE	SYSTEM WATTAGE				TRADITIONAL WATTAGE EQUIVALENT	DLC ID#
								DTC60WDIMCSU48		DTC30WDIMCSU48			
								4	3	2	1		
<b>T8 TUBES</b>													
<b>2' LENGTH</b>													
	15347	L9WT8/24/CDG/35K	7.92	1100	122	3500	83	36	27	18	9	17W Fluorescent	Pending
	15348	L9WT8/24/CDG/40K	7.92	1100	122	4000	83	36	27	18	9	17W Fluorescent	Pending
	15349	L9WT8/24/CDG/50K	7.92	1100	122	5000	83	36	27	18	9	17W Fluorescent	Pending
<b>3' LENGTH</b>													
	15323	L11.5WT8/36/CDG/35K	10.12	1500	130	3500	83	46	34.5	23	11.5	25W Fluorescent	Pending
	15325	L11.5WT8/36/CDG/40K	10.12	1500	130	4000	83	46	34.5	23	11.5	25W Fluorescent	Pending
	15326	L11.5WT8/36/CDG/50K	10.12	1500	130	5000	83	46	34.5	23	11.5	25W Fluorescent	Pending
<b>4' LENGTH</b>													
	15327	L11.5WT8/48/CDG/35K	10.12	1850	160	3500	83	46	34.5	23	11.5	25W Fluorescent	Pending
	15328	L11.5WT8/48/CDG/40K	10.12	1850	160	4000	83	46	34.5	23	11.5	25W Fluorescent	Pending
	15329	L11.5WT8/48/CDG/50K	10.12	1850	160	5000	83	46	34.5	23	11.5	25W Fluorescent	Pending
	15331	L13.5WT8/48/CDG/35K	11.88	2200	162	3500	83	54	40.5	27	13.5	32W Fluorescent	Pending
	15332	L13.5WT8/48/CDG/40K	11.88	2200	162	4000	83	54	40.5	27	13.5	32W Fluorescent	Pending
	15333	L13.5WT8/48/CDG/50K	11.88	2200	162	5000	83	54	40.5	27	13.5	32W Fluorescent	Pending
<b>T8 U-BENDS</b>													
<b>1-5/8" INCH</b>													
	15337	L15WT8/U1/CDG/35K	13.2	2200	146	3500	83	60	45	30	15	25W Fluorescent	Pending
	15338	L15WT8/U1/CDG/40K	13.2	2200	146	4000	83	60	45	30	15	25W Fluorescent	Pending
	15339	L15WT8/U1/CDG/50K	13.2	2200	146	5000	83	60	45	30	15	25W Fluorescent	Pending
<b>6" INCH</b>													
	15340	L15WT8/U6/CDG/35K	13.2	2200	146	3500	83	60	45	30	15	25W Fluorescent	Pending
	15341	L15WT8/U6/CDG/40K	13.2	2200	146	4000	83	60	45	30	15	25W Fluorescent	Pending
	15342	L15WT8/U6/CDG/50K	13.2	2200	146	5000	83	60	45	30	15	25W Fluorescent	Pending

## DRIVERS

ORDER	ORDER CODE	ITEM #	INPUT VOLTAGE (VAC)	MAX CURRENT (A) @ 120VAC	MAX OUTPUT POWER (W)	OUTPUT VOLTAGE (VDC)	MAX TUBES
	15313	DTC30WDIMCSU48	120-277	0.250	30	48	2
	15321	DTC60WDIMCSU48	120-277	0.500	60	48	4

### TYPE C DRIVER DIP SWITCH SETTINGS

#### DTC30WDIMCSU48 - 30W 120-277V DRIVER

SINGLE LAMP WATTAGE	MAX TUBES	MIN TUBES	S1	S2	S3
9W	2	1	ON	ON	ON
11.5W	2	1	ON	OFF	ON
13.5W	2	1	OFF	OFF	ON
15W	2	1	ON	ON	OFF
24W	1	1	OFF	ON	OFF

#### DTC60WDIMCSU48 - 60W 120-277V DRIVER

SINGLE LAMP WATTAGE	MAX TUBES	MIN TUBES	S1	S2	S3
9W	4	1	ON	ON	ON
11.5W	4	1	ON	OFF	ON
13.5W	4	1	OFF	OFF	ON
15W	4	1	ON	ON	OFF
24W	2	1	OFF	ON	OFF

# COMPATIBLE EMERGENCY BATTERIES

ORDER CODE	ITEM #	DESCRIPTION	INPUT VOLTAGE	EMERGENCY TIME	OUTPUT POWER	BACKUP LUMENS	RECHARGE TIME	TITLE 20
11675	EEBE18WHA170S	External Emergency Battery, 18W	120-347V	>90 mins	18W	Refer to lamp*	24 hrs	Yes

\* Refer to the lamp's lumen output for the Backup Lumens

## PRODUCT DIMENSIONS

A

### T8 - 2 FT.

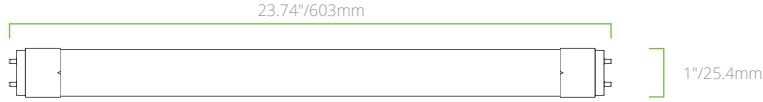

### T8 - 3 FT.

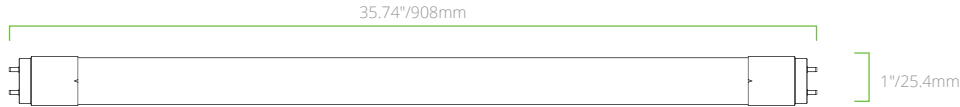

### T8 - 4 FT.

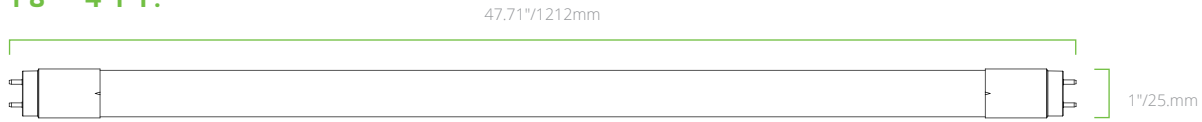

### U1

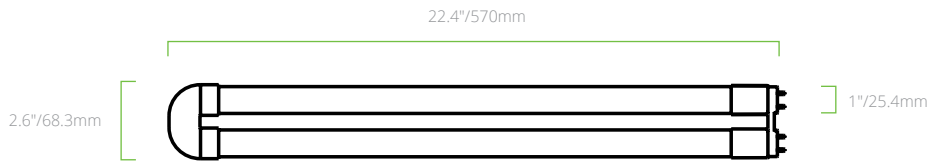

### U6

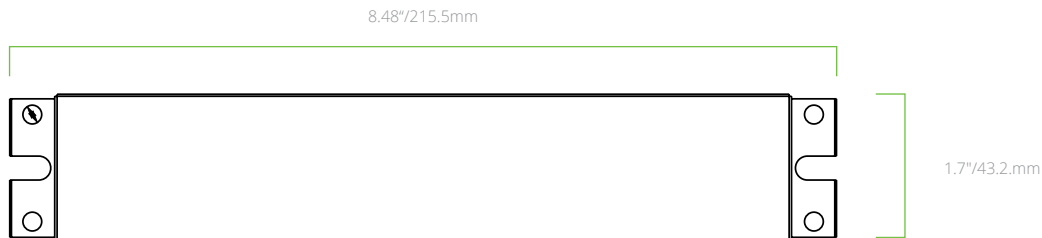
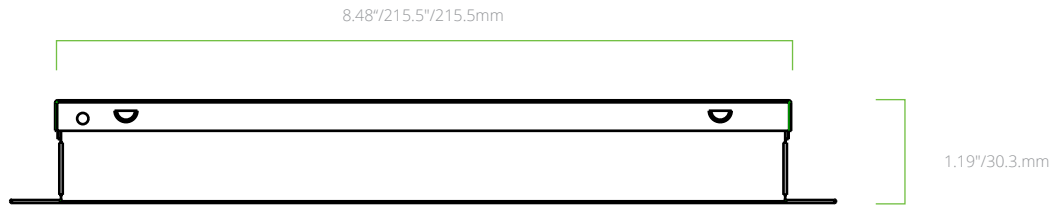
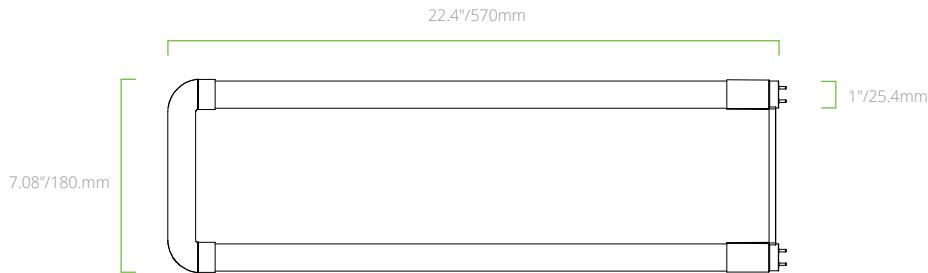

Linear T8/T5 Type C LED Driver Wiring for 1-4 Lamps

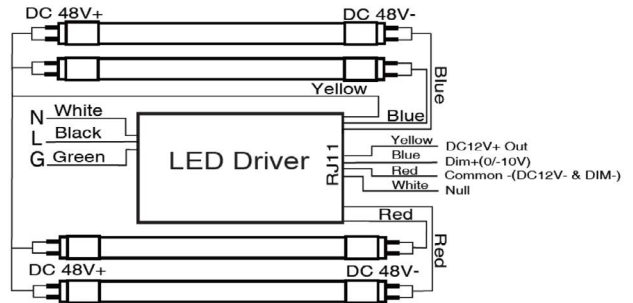
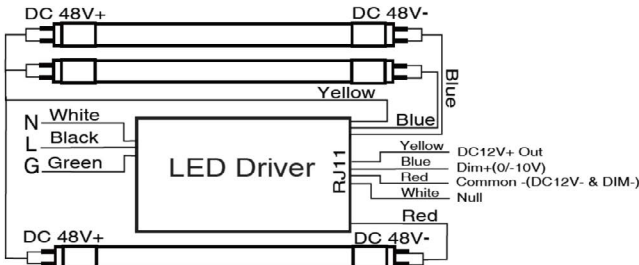
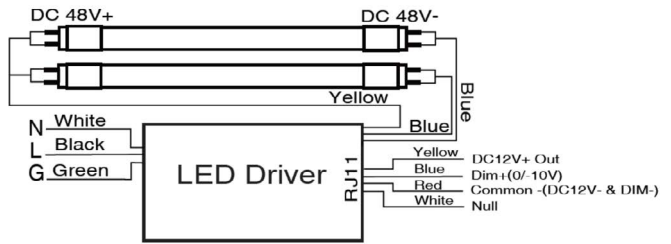
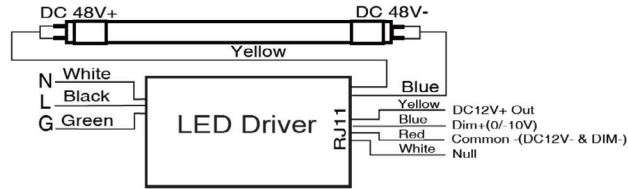

U-Bend T8 Type C LED Driver Wiring for 1-3 Lamps

