



## BP1 Backlit Flat Panel

### HIGHLIGHTS

- Low profile design is ideal for shallow plenum spaces
- Backlit design provides direct light and does not require a light guide plate
- The use of a high-quality, non-yellowing PMMA diffuse lens ensures optimal light uniformity
- Lightweight design makes it easier and faster to install
- Available in 1'x4', 2'x2' and 2'x4' sizes
- PowerSet feature allows for multiple lumen stops out of the box
- FieldCCeT features provides multiple color temperature settings in one fixture

### CERTIFICATIONS

- ETL listed for US & Canada
- Plenum rated
- RoHS Compliant
- FCC Compliant
- ICES-005 Compliant
- IC Rated for insulation contact
- Damp Location rated
- DesignLights Consortium® Qualified - meets DLC requirements for efficacy and lumen maintenance
- DesignLights Consortium® Premium Qualified - meets the requirements for the highest DLC qualification for efficacy and lumen maintenance

### PERFORMANCE

- High efficacy, up to 125 lm/W
- Available in fixed wattage models: 30W and 40W and PowerSet models: power-selectable 30/25/20W, 40/30/25W or 50/40/30W
- Available in single CCT models: 4000K and FieldCCeT models: field-selectable CCT 35/40/5000K
- CRI: >80
- Beam Angle: 120°
- Estimated L70: 100,000 Hours

### ELECTRICAL

- Input voltage: 120-277V or 120-347V
- 0-10V dimming, dim-to-off
- Surge Protection: 2 kV
- Power Factor: >0.9
- THD: <20%

### THERMAL

- -4°F to 113°F (-20°C to 45°C) ambient operating temperature

### CONSTRUCTION

- White powder coated aluminum frame
- Non-yellowing PMMA diffuse lens

### WARRANTY

- 5-Year limited warranty available [online](#). Contact your EiKO sales rep for additional details.

project name	type
catalog number	voltage
approved by	date



1X4

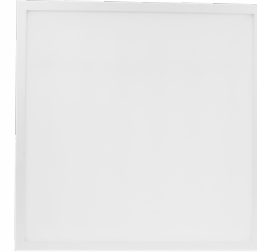

2X2

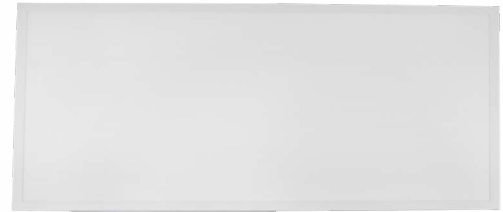

2X4



### APPLICATIONS

- Office
- Hospitals
- Retail
- Schools
- General Purpose lighting

## KEY FEATURES

### IMPROVED BACKLIT DESIGN

Backlit design uses an LED arrangement across the entire panel enabling direct lighting that does not require the dispersal of light via a light guide plate. This allows for more efficient lighting and an overall construction that is extremely lightweight, while resisting bowing when hung.

### EXTENDED JUNCTION BOX

Four knockouts and a 6" junction box allows for easy access and quick installations.

### CONTROL READY

CR versions are control-ready fixtures, allowing us to add plug-and-play sensors in seconds.

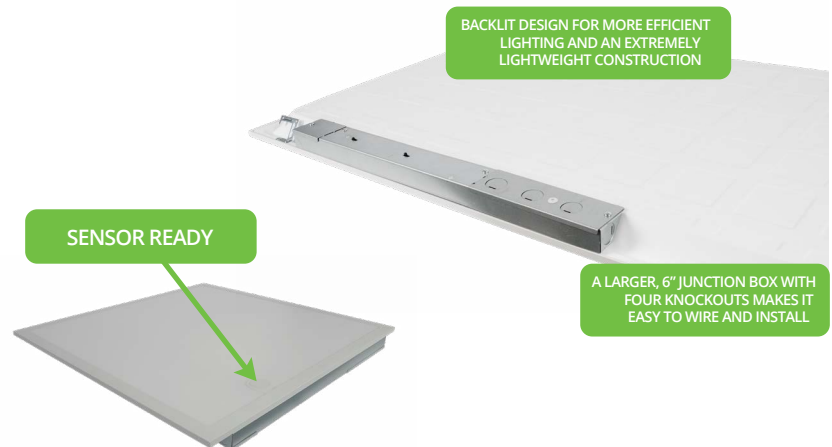

## AVAILABLE MODELS

ORDER	ORDER CODE	ITEM #	SIZE	WATTS**	CCT***	LUMENS	EFFICACY (lm/W)	VOLTAGE	TRADITIONAL WATTAGE EQUIVALENT	DLC ID#	
										STANDARD	PREMIUM
<b>1x4</b>											
	13174	BP1-14PS40S-40-H	1x4	40/30/25	4000	4400/3300/2750	110	120-347	2 x 32W 4ft T8	S-HOE8P9	
	13179	BP1-14PS30P-FCCT-H*	1x4	30/25/20	35/40/5000	3750/3125/2500	125	120-347	2 x 32W 4ft T8		S-YBLQGV
<b>2x2</b>											
	13169	BP1-2230S-40-U	2x2	30	4000	3300	110	120-277	2 x 17W 2ft T8	S-MAG6DQ	
	13172	BP1-22PS30P-40-U	2x2	30/25/20	4000	3750/3125/2500	125	120-277	2 x 17W 2ft T8		S-PNDBU5
	13180	BP1-22PS30P-FCCT-H*	2x2	30/25/20	35/40/5000	3750/3125/2500	125	120-347	2 x 17W 2ft T8		S-JTY408
	14360	BP1-22PS30P-FCCT-H-CR	2x2	30/25/20	35/40/5000	3750/3125/2500	125	120-347	2 x 17W 2ft T8		S-JTY408
	13175	BP1-22PS40S-40-H	2x2	40/30/25	4000	4400/3300/2750	110	120-347	2 x 17W 2ft T8	S-ZKG731	
<b>2x4</b>											
	13170	BP1-2430S-40-U	2x4	30	4000	3300	110	120-277	4 x 32W 4ft T8	S-2ZDV4T	
	13173	BP1-24PS30P-40-U	2x4	30/25/20	4000	3750/3125/2500	125	120-277	4 x 32W 4ft T8		S-OD6MLY
	13176	BP1-24PS40S-40-H	2x4	40/30/25	4000	4400/3300/2750	110	120-347	4 x 32W 4ft T8	S-4EU69J	
	13177	BP1-24PS40P-40-H	2x4	40/30/25	4000	5000/3750/3125	125	120-347	4 x 32W 4ft T8		S-RXBM7P
	13171	BP1-2440S-40-U	2x4	40	4000	4400	110	120-277	4 x 32W 4ft T8	S-RBC2AG	
	13178	BP1-24PS50S-FCCT-U	2x4	50/40/30	35/40/5000	5500/4400/3300	110	120-277	4 x 32W 4ft T8	S-ICK6XZ	
	13181	BP1-24PS50P-FCCT-H*	2x4	50/40/30	35/40/5000	6250/5000/3750	125	120-347	4 x 32W 4ft T8		S-JFYTHL S-TKFTDT
	14361	BP1-24PS50P-FCCT-H-CR	2x4	50/40/30	35/40/5000	6250/5000/3750	125	120-347	4 x 32W 4ft T8		S-JFYTHL S-TKFTDT

\* Eiko Advantage Product

\*\* All power-selectable fixtures ship at the highest wattage setting

\*\*\* All CCT-selectable fixtures ship at 4000K

## FACTORY INSTALLED OPTIONS

CUSTOM CORD LENGTH	BATTERY BACKUP	CONTROLS
<p><b>[Blank]:</b> Default no cord</p> <p><b>A1xx:</b> 300V 18/3 armored cable, XX to specify length up to 99'</p> <p><b>A2xx:</b> 600V 18/3 armored cable, XX to specify length up to 99'</p> <p><b>W3xx:</b> 600V 18/6 white service cord with dimming wires and a 24/7 hot wire for battery backup</p> <p>Custom length required (in feet)</p>	<p><b>[Blank]:</b> Default, no battery back-up</p> <p><b>EB08*:</b> 8W, External Backup battery 100-347V</p> <p><b>EB18*:</b> 18W, External Backup battery 100-347V</p>	<p><b>[Blank]:</b> Default, no no control</p> <p><b>M14:</b> Stand-alone PIR Motion Sensor, 8-12ft change M21</p> <p><b>M21:</b> Bluetooth NLC PIR Motion sensor, 8-12ft</p>

\*Batteries are wired, not secured to the fixture. EEBE-FTB flat test button & indicator are included with the factory battery install modification.

## MODEL CONFIGURATOR

MODEL	SIZE	WATTS	DLC	CCT	VOLTAGE	AUX POWER	CORD LENGTH	BATTERY BACKUP	CONTROLS
BP1	14 = 1' by 4' 22 = 2' by 2' 24 = 2' by 4'	PS = Power Selectable 30 = 30 Watts 40 = 40 Watts 50 = 50 Watts	P = DLC Premium S = DLC Standard	FCCT = Color Temperature Selectable 40 = 4000K 50 = 5000K	U = 120-277V H = 120-347V	CR = Control Ready			

EXAMPLE PART NUMBER: BP1-24PS50P-FCCT-H-CR-EB08-M21

REFER TO FOLLOWING SECTIONS FOR DETAILS ON FACTORY INSTALLED OPTIONS & AVAILABLE FIELD INSTALLED OPTIONS

## ACCESSORIES

ORDER	ORDER CODE	ITEM #	DESCRIPTION	IMAGE
<b>MOUNTING ACCESSORIES</b>				
	13909	FP1-SMK-14	FP1 Surface Mount Kit For 1x4 Flat Panels and Troffers	
	13908	FP1-SMK-22	FP1 Surface Mount Kit For 2x2 Flat Panels and Troffers	
	13912	FP1-SMK-24	FP1 Surface Mount Kit For 2x4 Flat Panels and Troffers	
	13913	FP1-RMK-14	FP1 Recessed Mount Kit For 1x4 Flat Panels and Troffers	
	13914	FP1-RMK-22	FP1 Recessed Mount Kit For 2x2 Flat Panels and Troffers	
	13915	FP1-RMK-24	FP1 Recessed Mount Kit For 2x4 Flat Panels and Troffers	

## BATTERY BACKUPS

ORDER	ORDER CODE	ITEM #	DESCRIPTION	FACTORY INSTALLED CODE
	11674	EEBE08WHA170S*	EiKO Emergency Battery External 8W 120-347V 170VDC Single Flex-Conduit CEC Compliant Factory or field install. See spec sheet for full details.	EB08
	11675	EEBE18WHA170S*	EiKO Emergency Battery External 18W 100-347V 170VDC Single Flex-Conduit CEC Compliant. Factory or field install. See spec sheet for full details.	EB18
	14982	EEBE-FTB	EEBE flat test button and indicator for Panel light and downlight.	--

**\* WARNING:** When using these AC version battery backups with any control solution, internal rewiring is required according to the installation sheet's wiring diagram. Failure to do so may result in a violation of safety codes.

## CONTROLS & SENSORS: FIELD OR FACTORY INSTALLED

ORDER	ORDER CODE	ITEM #	DESCRIPTION	IMAGE	FACTORY INSTALLED CODE
<b>STANDALONE CONTROLS</b>					
<b>PLUG AND PLAY SENSORS</b>					
	13697	SENA-SHPR	Stand-alone PIR Motion Sensor, 12-14V, 1/2" Button Snap-in, 0-10V, Daylight Harvesting, 8-12ft, Default settings can be modified by SEN5A-ACT.		M14
<b>REMOTES FOR COMMISSIONING PLUG AND PLAY SENSORS</b>					
	13344	SEN5A-ACT	Commissioning Tool for SEN5A, BAY-E-SEN/PIR, BAY-E-SEN/M, and MS2-DPX-3. (Backward compatible with SEN5A/CT and RC-100)		---
<b>NETWORKED LIGHTING CONTROLS (NLC)</b>					
<b>PLUG AND PLAY SENSOR</b>					
	15439	SEN-WSI-PIR-A	BLE PIR Motion sensor, 12-24V, Screw-in, 0-10V, Daylight Harvesting, 8-40ft, White, IP65, Parameters set by Silvair App <b>Note:</b> Optional sensitivity can be adjusted by SEN5A-ACT.		M21
<b>CEILING MOUNT SENSOR</b>					
	13359	SENA-WCPA	BLE PIR Motion sensor, 12-24V, Ceiling Mount, 0-10V, Daylight Harvesting, 12ft, OD3.3" WhiteTrim (ID2.7"), Parameters set by Silvair App. <b>Note:</b> Requires a power supply of 12VDC from the <b>PSC-WCM-450-BLE-SR</b> for proper operation.		---
<b>WALL OR WIRELESS CONTROLLERS</b>					
	12654	ESRPB-W-EO	BLE Easyfit by EnOcean wireless self-powered kinetic Single rocker pad, white, wall plate included.		---
	12655	EDRPB-W-EO	BLE Easyfit by EnOcean wireless self-powered kinetic Double rocker pad, white, wall plate included.		---
	12635	PSC-DM-WS-100-BLE-SR	BLE TruBlu 120-277V, Single Gang Single Button Wall Controller, White, Parameters set by Silvair App.		---
	12636	PSC-DM-I-WS-100-BLE-SR	BLE TruBlu PIR Occupancy/ Vacancy Sensor, 120-277V, Single Gang Wall Controller, White, Parameters set by Silvair App.		---
	12637	PSC-DM-WS-400-BLE-SR	BLE TruBlu 4-Button Wall Controller, 120-277V, Single Gang, White, Parameters set by Silvair App.		---
<b>GATEWAY AND RANGE EXTERNDER</b>					
	13234	SGW-101	BLE Silvair Gateway SGW-101 Manufactured by Rigado (model: Cascade-500). 5-year from Silvair warranty and tech support.		---
	12994	PSC-RET-100-BLE-SR	BLE TruBlu Range Extender, 120-277V, 800ft, NEMA 4X Outdoor Enclosure		---
	12993	PSC-TKP-200-BLE-SR	BLE TruBlu Battery Backup Timekeeper and Range Extender, 120V, 800ft, NEMA 4X Outdoor Enclosure		---

# PRODUCT DIMENSIONS

## 1X4 MODELS

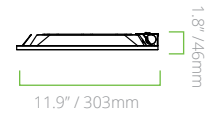
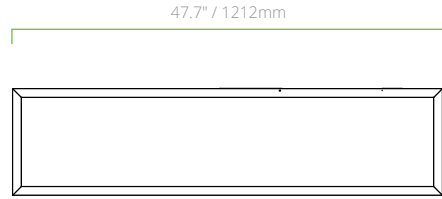

Weight: 5.0 lbs / 2.3 kg

## 2X2 MODELS

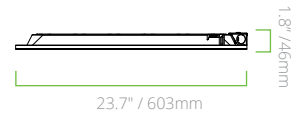
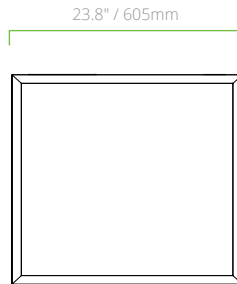

Weight: 4.6 lbs / 2.1 kg

## 2X4 MODELS

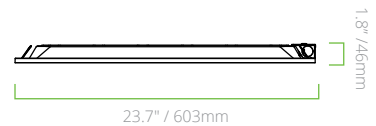
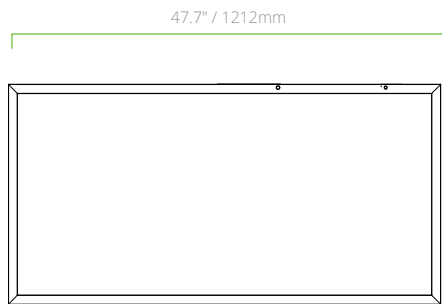

Weight: 8.4 lbs / 3.8 kg